

The Perfect Balance of Precision & Comfort

product catalog & spec guide



AKTINA
M E D I C A L

Table of Contents

positionPRO™	4-7
PinPoint Radiosurgery	8-9
PinPoint SRS Phantom	10-11
Small Field Circular Cones.....	12-13
Memorial Cradle 2	14-17
Respiratory Compression Belt.....	18-19
SenoView Prone Breast System	20-21
Axion 1 Carbon Fiber Breast Board.....	22-23
Elekta Active Breathing Coordinator™	24-25
Elekta ABC Accessories.....	26-29
SpiroCheck Duo	30-31
Thermoplastics.....	32-39
AK550 Couch Top System	40-45
Electron Beam Shaping System.....	46-49
LINAC Accessories	50-65
..... Mechanical Front Pointers.....	51
..... Port Film Graticules.....	52-53
..... Photon Lead Block System.....	54
..... Radiation Safety Monitors	55
..... Rigid Water.....	56
..... Rigid Water Physics Phantom	57
..... Protos Phantom	58-59
..... Film Cassette Holders.....	60
..... Model LINAC	61
..... Wedge Filter Kits.....	62
..... Beam Block Trays.....	63
LAP Room Laser Systems.....	64-65
Contact Us.....	66
Index	67



Together we can make a difference

Aktina Medical brings a unique perspective to the Radiation Oncology community. Founded over 25 years ago and still run today by Medical Physicists, Aktina maintains a deep commitment to developing products and solutions that not only assist in the most accurate cancer therapy possible, but are also innovative and inspiring in their design.

Aktina Medical is owned and operated by certified Medical Physicists with over 30 years of expertise in Radiation Oncology. Our unique combination of consultation services and experience in designing and manufacturing quality radiation oncology systems makes Aktina a primary source for your department's Radiation Oncology needs.



Creating products for radiation therapy requires more than just technical expertise – it requires a close connection with those who are delivering the therapy – and with the patients who are struggling through a demanding process.

There is an artistry within every successful product. A balance of form and function that leaves the physician and therapist more confident after every use, and allows the patient to focus on what matters most: their health.

The most useful and helpful products are born from the integration of many disciplines. Aktina Medical's physicists routinely consult with their product experts – and the product managers, sales team, and engineers rely on the field experiences of the physics group to continuously improve their solutions and services. This unique combination of clinical and technological expertise creates a synergy for exceptional results.

Aktina Medical also works with small and large hospitals and University Centers. Through such collaborative efforts, Aktina's products are developed with a clarity of purpose, usability, and outcome that will truly excite you.



Company History

- 1962** The Radiation Oncology department at Montefiore Medical Center (Bronx, NY) bought the world's first 35MV clinical Betatron from Brown Boveri (Baden, Switzerland). That same year, George Zacharopoulos, a recent Columbia University physics graduate, joined Montefiore's clinical physics operations team.
- 1966** Mr. Zacharopoulos became the Chief Physicist in Radiation Oncology and remained in that position for 25 years.
- 1970** In the early part of the decade, Montefiore bought and installed the first Siemens Mevatron accelerator at their Einstein campus. Realizing that more advanced clinical tools were needed for the accelerator, Mr. Zacharopoulos soon began designing a multitude of different products which were manufactured with help from his entire family. Initial products included tangential breast bridges, electron beam shaping systems, front pointers, port film graticules and wedge filters.
- 1986** Aktina Medical Physics Group was officially formed and supplemented its product offering with the formation of a consulting group to provide on-site clinical support to hospitals and facilities nation-wide.
- 1993** Aktina Medical opened its state of the art robotic manufacturing facility in Congers, NY where it has since expanded its product line to include several hundred items.
- 2011** Over the years, the Zacharopoulos family has continued to grow with multiple sons and daughters actively involved in Aktina's daily operations. The family-like environment at Aktina fosters the original inspiration for the company to make a positive difference in the treatment of cancer.
- 2014** The Aktina Medical product line continues to grow. It now covers all aspects of radiation oncology from physics QA to patient immobilization.
- 2017** Continued expansion of our manufacturing facility to meet our customers growing needs. This investment has led to more efficient and faster production capabilities.
- 2020** Aktina Medical's ongoing growth has led to exciting new product innovations and expanded partnerships with industry leading organizations.

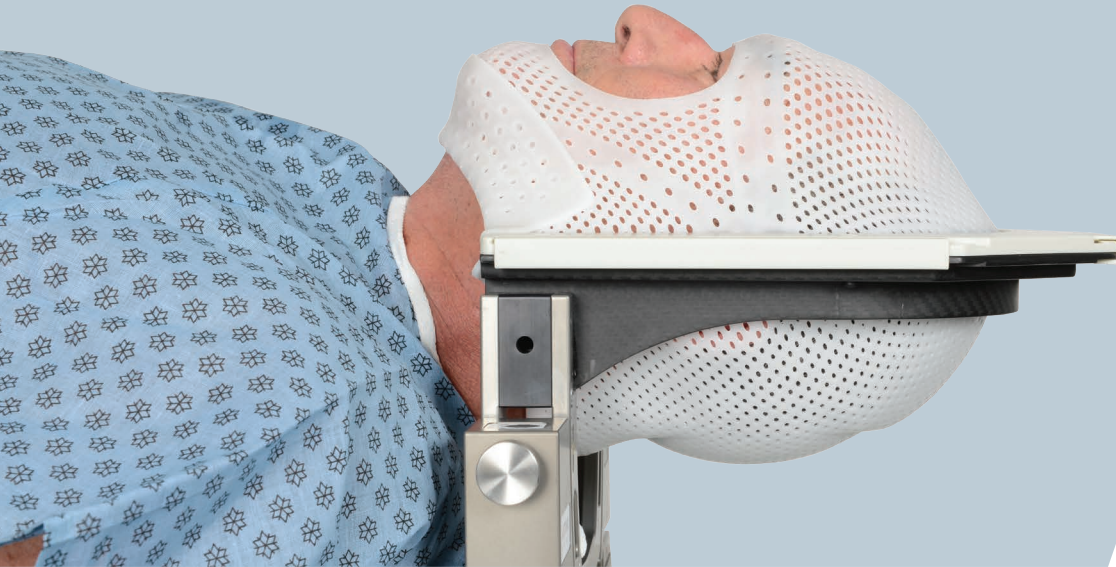

positionPRO™ is a modular pitch and roll correction enabled immobilization system for cranial, C-spine, and head and neck treatments. This innovative modular solution provides patient immobilization and precision position correction for intracranial, C-spine, and head and neck regions.

Clinical Benefits

Pitch and roll corrections are easily performed with simple adjustment knobs. Real world shifts are translated with an accurate and easy to read degree scale.

Treat Multiple Sites With a Single Device

- Intracranial SRS, head and neck, and C-spine treatments are all facilitated with the EZ-swap modules.

Uniform Density and Secure Immobilization

- The unique locking channels slide on with ease and provide a large footprint of fixation. This also allows for a very dosimetrically uniform design with no bulky beam impeding closures or base plates.

Thermoplastic Flexibility

- Enhanced open face or standard closed masks are available for use with the EZ-swap head support modules. A head support riser enables precise, reproducible, and easy thermoplastic hammock formation.

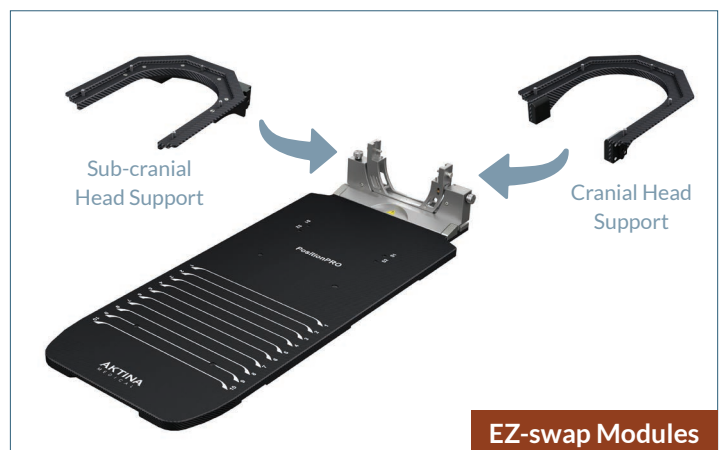

The EZ-swap head support modules are designed to improve and expedite clinical workflow for intracranial radiosurgery, head and neck, and C-spine SBRT.



Pitch: down



Pitch: up

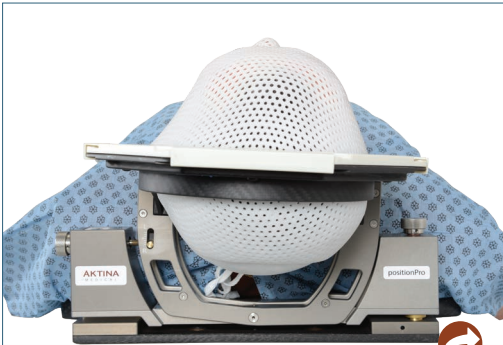

Roll: right

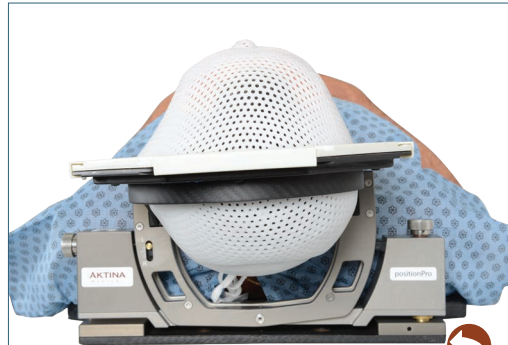

Roll: left



Scale closeup



Head and neck module shown





positionPRO Pitch and Roll Overlay

REF: 50-840

The positionPRO Pitch and Roll Overlay is the main component of the immobilization system. It is designed to improve and expedite clinical workflow with EZ-swap head support modules for intracranial radiosurgery, head and neck, and C-spine SBRT.

The cross-platform design permits use with all manufacturers and the HexaPOD friendly width allows use with the Elekta HexaPOD system.

Sub-cranial Head Support

REF: 50-806

The positionPRO Sub-cranial Head Support is designed to allow the clinician maximum range and freedom for treatments in the head and neck region. Sharing the same EZ-swap interface as the rest of the positionPRO suite makes the unit quickly adapted. Posterior and anterior thermoplastics are both accommodated as well as the unique sliding mask locks. Use this head support for all C-spine and head and neck treatments.



Head and Neck Module



Cranial Head Support

REF: 50-805

The positionPRO Cranial Head Support is designed to hold the patients head for intracranial treatments. The EZ-swap interface allows the unit to be quickly fitted to the positionPRO pitch and roll correcting overlay. This allows the unit to be cantilevered from the treatment couch for optimal beam clearance while performing posterior treatments. Posterior and anterior thermoplastics as well as the unique sliding mask locks are accommodated.



Cranial Module



PinPoint Arch Kit

REF: 50-807

The PinPoint Arch Kit allows pitch and roll correction while using the proven Aktina PinPoint hard-palate vacuum fixation. It combines the positionPRO pitch and roll baseboard with the Aktina PinPoint vacuum-based head immobilizer. No anterior mask is used in this configuration.



armAssist Hand Grip

REF: 50-832

The armAssist Hand Grip holds the patients arms still during treatment with a comfortable hand position. The armAssist adjusts in the sup/inf direction for optimal flexibility.



Head Riser

REF: 50-855

The Head Riser supports the patient's head during formation of the posterior thermoplastic hammock.

With indexed positioning and simple height adjustments, it can be tailored to the exact patient's anatomy and clinical setup. A screw up/down design allows for simple height adjustments.



Standard Mask Kit

REF: 40-720

Includes a posterior and anterior thermoplastic mask. Each kit includes three clamping channels that are used to secure the masks during treatment.

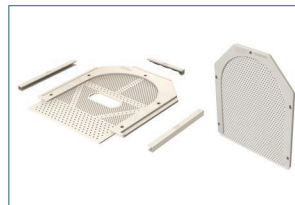

Enhanced Mask Kit

REF: 40-721

Similar to the 40-720 except it contains enhanced thermoplastic reinforced areas.



Anterior Mask

REF: 50-810



Posterior Mask

REF: 50-820

Thermoplastic Head Support



The Thermoplastic Head Support combines the advantages of the Alpha- and the Vacuum-type solutions. It is extremely accurate and easy to use.

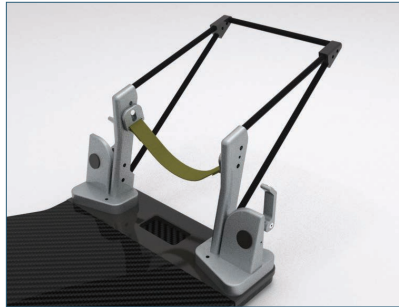

Thermoplastic Support Assembly
REF: 50-265

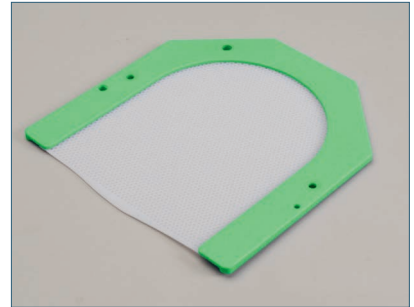

PinPoint Thermoplastic Hammock
REF: 50-266

Hardware and Tools

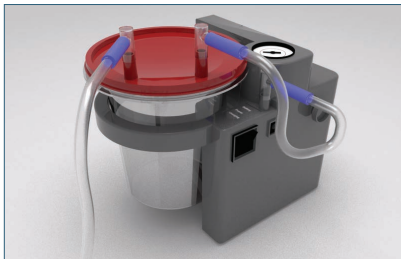

PinPoint Vacuum Pump

REF: 50-175

The portable pump is small and quiet and provides the vacuum pressure for the mouthpiece fixation. Rechargeable batteries provide convenience and ease of use during setups and treatments.

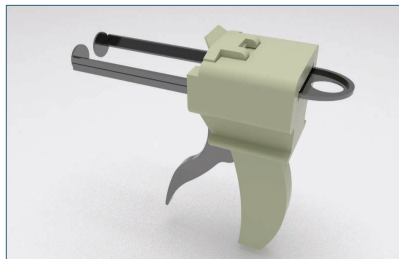

Dental Impression Applicator

REF: 50-220

The applicator is used to dispense dental impression material when creating vacuum mouthpieces.



PinPoint Torque Wrench

REF: 50-141

Pre-set torque wrench with 3/8" hex bit.

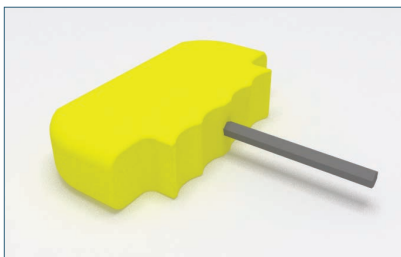

PinPoint Ergo-Grip Allen Key

REF: 50-146

PinPoint optimized handle shape and allen key length.



Arch Block

REF: 50-144

The Arch Block integrates the patient's Mouthpiece Assembly to the Arch. It is patient specific and reusable (each concurrent patient will require one).

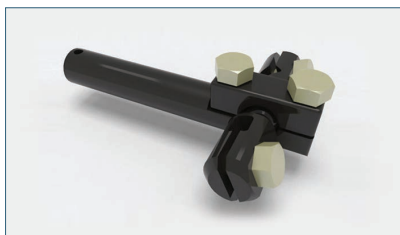

Mouthpiece Holder, Medium

REF: 50-152

With a 10cm stem, the Medium Mouthpiece Holder is ideal for most cranial applications. It is patient specific and reusable (each concurrent patient will require one).

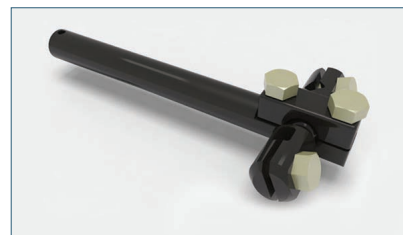

Mouthpiece Holder, Large

REF: 50-153

With a 16cm stem, the Large Mouthpiece Holder is ideal for base of cranial, and head and neck treatments. It is patient specific and reusable (each concurrent patient will require one).

Consumables



Dental Impression Material

REF: 50-222

The impression material is used in the PinPoint frameless SRS system to create the patient's custom fabricated vacuum mouthpiece. Each box includes a quantity of four, 50mL tubes and 12 mixing tips (each tube is capable of providing enough material for one mouthpiece).



Mouthpiece Adhesive

REF: 50-215

The Mouthpiece Adhesive is used when creating a patient specific vacuum mouthpiece. It holds the impression material to the vacuum mouthpiece. Each bottle contains enough adhesive for approximately 100 patients.

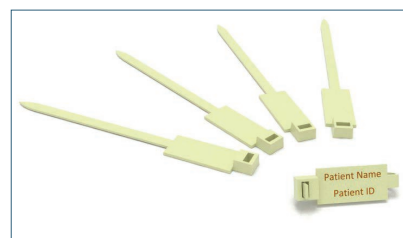

PinPoint Patient ID Label

REF: 50-227

The Patient ID label is designed to fit ergonomically to the Patient Specific Assembly. The writeable area is approximately 3.0cm x 1.3cm. The patient's name and ID should be written onto the label with an indelible marker. It is a one-time-use item. Pack of 30.



Mouthpiece Tubing Kit

REF: 50-225

The PinPoint Mouthpiece Tubing Kit allows for the Vacuum Mouthpiece to be connected to the Bemis container tubing. Each tubing kit is individually packaged.



Bemis Container Kit

REF: 50-245

Replacement containers for PinPoint vacuum pump contains all the necessary tubing and connectors for connection to the pump.



Vacuum Fixation Mouthpiece

The PinPoint Vacuum Fixation Mouthpiece is used to create a patient specific impression of the patient's palate. It is a one-time-use item. Box of 10: 3 small, 4 medium, and 3 large.

REF: 50-455 - Small, Set of 10
 REF: 50-460 - Medium, Set of 10
 REF: 50-465 - Large, Set of 10
 REF: 50-470 - Assorted, Set of 10
 (3 S, 4 M, 3 L)

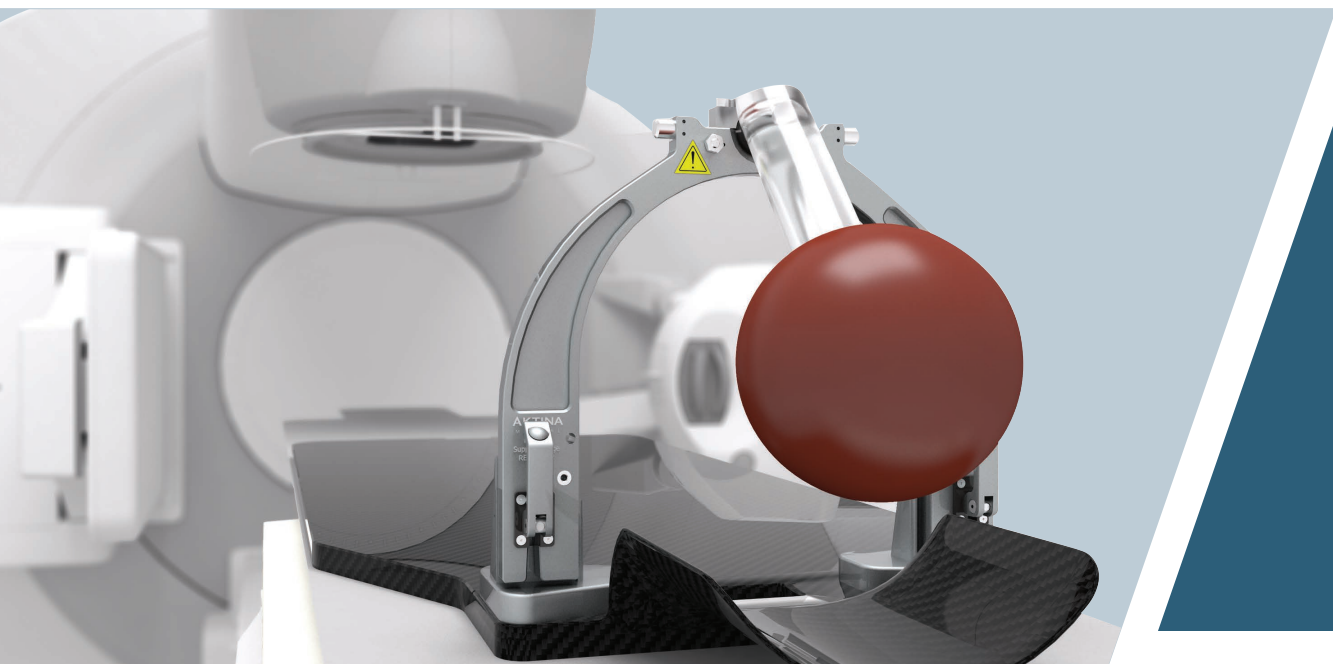

The PinPoint SRS Phantom is made of Aktina Rigid Water and attaches directly to the patient interface of the PinPoint system. Three removable cores allow for chamber measurements, and film measurements along 3 orthogonal directions. Custom chamber holes can be machined at the customer's request. The phantom allows for complete system QA of the Aktina PinPoint SRS localization and fixation system.

Since the phantom integrates into the Aktina PinPoint SRS system, it allows for a complete start to finish QA of your clinical SRS program.

Localization for phantom measurements can be performed with whichever technique is being used clinically: stereotactic or 3-point localization (see page 12 for more details).



Technical Specifications

Material	Aktina Rigid Water
Weight	2.1kg body 0.5kg each insert
Interface	Aktina non-invasive SRS system
Dimensions	15cm diameter sphere
Film Type	Gafchromic® from ISP
Film Size	5.5cm square (with one asymmetrical corner)

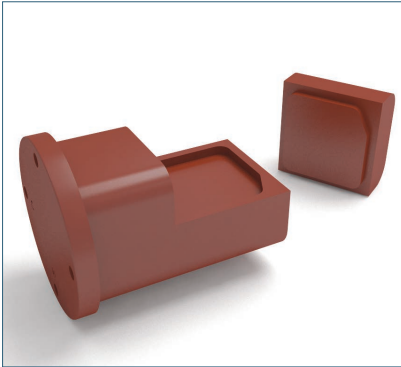

Coronal/Sagittal Film Insert

REF: 50-250-06

The Coronal / Sagittal Film Insert is used with the PinPoint SRS Phantom and allows for precision cut films to be placed in either the patient's sagittal or coronal planes. The insert is labeled with indicators which show the orientation of the insert without having to remove the insert to inspect the film.



Ion-Chamber Film Insert

REF: 50-250-08

The Ion-Chamber Film Insert is used with the PinPoint SRS Phantom and allows for various ion-chambers to be positioned within core of the spherical phantom. The Ion-Chamber Insert comes with one solid and one drilled core which will snugly fit your ion-chamber. The cores can be interchanged to place the ion-chamber on or off the center of the spherical phantom.

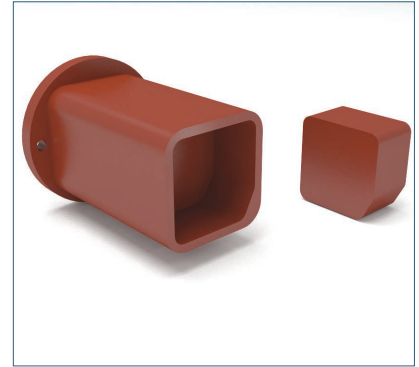

Axial Film Insert

REF: 50-250-02

The Axial Insert is used with the PinPoint SRS Phantom and allows for precision cut films to be placed in the patient's axial plane. The insert is precision machined to fit accurately with the phantom main body. The film pocket is asymmetrical to minimize any confusion when making measurements.



PinPoint Precision Cut Film

REF: 50-252

The PinPoint Precision Cut Film is manufactured to fit into the PinPoint phantom with a high level of accuracy in order to make determination of spatial positioning of SRS fields. The film type is Gafchromic® from ISP. The films are asymmetrical to minimize any confusion when making measurements. Each pack includes 25 pieces of film.

Ordering Information

Part Number (REF:)	Description
50-251	PinPoint SRS Phantom System
50-251-01	Main Body
50-250-02	Axial Film Insert
50-250-06	Coronal/Sagittal Film Insert
50-250-08	Ion-Chamber Insert
50-252	Precision Cut Film Pack

Small Field Circular Cones

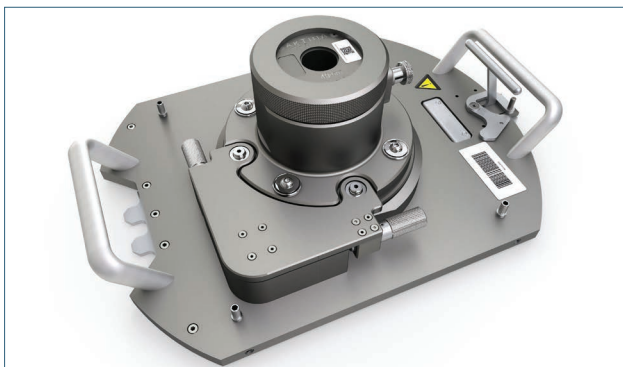

SRS Cone Adapter

REF: 50-370

Aktina's Small Field Circular Collimators are safe, light-weight, simple to use, and extremely accurate. The Adapter simply snaps onto the Elekta LINAC head without the need for modifications to the collimator face plate. Inter-changeable cones are provided over a range of 5 through 40mm field sizes (increments of 1mm). Each cone is uniquely recognized by the Elekta LINAC by a simple coding system: code value = size of the cone in mm. This reduces potential errors that could occur at treatment.

The system has been jointly validated by Aktina and Elekta and is compatible with Elekta's bar code scanner system for jaw size verification.

The precision LINAC interface is extremely reproducible without any play.



SRS Cone with various size inserts

Technical Specifications

LINAC Compatibility	Elekta Digital Accelerators (with bar code scanning)
MLC Compatibility	Agility and MLCi2
Linac Interface	Direct Mount
Adapter Weight	6.9kg (15.2 lbs)
Cone Weight	5.2 - 5.6kg (11 - 12 lbs)
Collimation Type	Divergent
Cone Sizes Available	5 through 40mm
Attenuating Material	Lead
Cone Exterior	Stainless Steel
Patient Clearance	33.1cm
Code Type	Beam Block Tray
Code Value	no cone: 64 with cone: cone size in mm QA insert: 63
TPS Compatibility	Monaco 5.11 or greater Pinnacle 9.10 or greater Raystation v5 (with DICOM filter applied)
IEC performance data	Available upon request (contact us)



Storage Cart for Adapter and Cone Inserts

REF: 50-371

Provides ability to store up to 9 cones and cone adapter on the top shelf, first and second shelves are available for other physics equipment.



Circular Small Field Cone Inserts

REF: 50-302

Inter-changeable cones are provided over a range of 4 through 40mm field sizes (increments of 1mm). Each cone is uniquely recognized by the Elekta LINAC by a simple coding system: code value = size of the cone in mm. This reduces potential errors that could occur at treatment. The precision LINAC interface is extremely reproducible within virtually no cone movement.

Technical Specification

Cone Weight	5.2 - 5.6kg (11 - 12 lbs)
Collimation Type	Divergent
Cone Size Range	4 through 40mm
Cone Size Increments	1mm
Attenuating Material	Lead
Cone Exterior	Stainless Steel
Penumbra Characteristics	2.0 - 2.6mm (20% to 80% distance, measured at 1.5cm depth)



QA Insert

REF: 50-305

The QA insert is used to check all the micro-switches of the cone adapter (REF: 50-370). Inserting this insert into the cone adapter should produce an interlock code value of 63. Any other value indicates a possible problem with the interlocking circuit.

Technical Specifications

Cone Insert Material	Plastic
Cone Insert Code	63

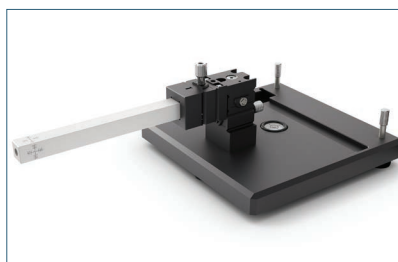

Lutz Marker Positioning System

REF: 50-335

The Lutz Marker Positioning System allows for high precision movements of a radio-opaque sphere in 3-dimensions. The system is ideal for verifying Gantry and Couch rotations for SRS treatments.

Technical Specifications

Arm Length	14cm
Ball Material	Tungsten
Ball Size	5mm
Travel Range	9.5mm in all three directions
Positioning Accuracy	80 pitch drives provide 1 μ m sensitivity



Film Holder

REF: 50-330

The Film Holder is compatible with Siemens Small Field Circular Cones and is used for Lutz type test to be performed in order to verify gantry iso-centricity. The adapter easily attaches to the Aktina Small Field Circular Cone Adapter (REF: 50-300) and positions films within the beam axis with a film spring-type retention mechanism.

Technical Specifications

Compatibility	Aktina Small Field Cone Adapter for Siemens LINAC
Weight	0.5kg (1.2 lbs)
Film Distance from Source	110cm
Buildup	3mm aluminum
Film Holding Mechanism	Steel spring



The Aktina Medical Lateral Support System takes a unique approach to SBRT immobilization. With an emphasis on modularity the system is geared toward decreasing attention and storage needs and increasing flexibility for the clinician. The lateral support paddles mount directly to the treatment couch - no need for additional accessories such as an overlay or mounting hardware.

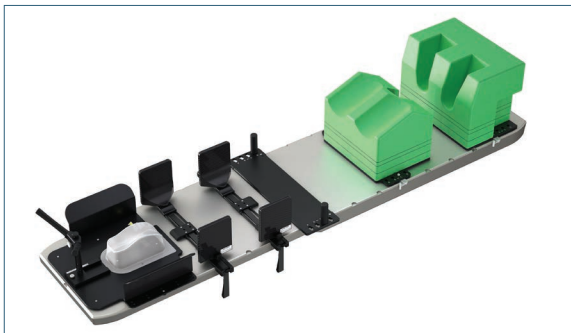

SBRT Complete System

REF: 60-100

The Memorial Cradle provides a unique method for patient immobilization. Originally Co-developed between Aktina Medical and Memorial Sloan Kettering Cancer Center, the system utilizes side pressure on the patient to achieve superior immobilization and patient comfort. This unique modular approach allows for excellent flexibility in SBRT positioning with direct index to table crossbar and paddle sets.

- Actively supports the patient in position – Only system available that applies lateral side pressure on the patient to increase inter- and intra-treatment setup accuracy and reproducibility
- Modular – The system is cost and space effective since only the components that are needed are to be purchased for use
- Open System – no bulky overlays – this minimizes attenuation and increases treatment options and flexibility
- Universal – Easily adapts to any treatment or CT couch top



Respiratory Compression Belt

The Respiratory Belt is designed to apply pressure to restrict movement due to the patient's respiratory cycle. The belt allows for the application of user defined pressure and is adjustable to allow for different size patients. The belt is available in small, medium and large sizes. See page 20 for more information.



Elekta couch shown



Varian couch shown



SBRT Lateral Pressure Positioning System

REF: 60-505

This is the main component of Aktina's unique SBRT system. It comprises of 1 SBRT Universal Lateral Pressure Indexing Bar (REF: 60-522) and 2 SBRT Lateral Paddles (REF: 60-525).

The SBRT Lateral Pressure assembly has a unique direct to couch top interlocking feature. This allows the assembly to fix directly to the treatment couch without the need for a bulky overlay, keeping attenuation low and increasing reproducibility. When used as a pair (shown above), one of the crossbars can float along the table in the sup/inf direction, greatly increasing possible indexing points.



ArmCradle 4

REF: 60-812



Shown with Included Vertical Handles

ArmCradle 4

REF: 60-812

The ArmCradle 4 sets a new standard for arm positioning in radiation therapy. The robust nature of the board creates an excellent standalone device for lung and abdomen treatments. This is also the go to solution for the Aktina SBRT positioning system. The ArmCradle 4 can be easily attached to the Axion 1 Breast Board (REF: 11-229) and immobilizes both arms out of the treatment field with multiple hand support options. The design incorporates two indexing mold blocks on either side of the board which are perfect for vac bag indexing and add rigidity for breast, lung and SBRT treatments.

ArmCradle Features:

- Superior Construction – the lightweight carbon fiber construction is extremely rigid.
- Versatile – a variety of treatments are achieved from the single device.
- Ergonomic – designed for the modern radiotherapy center.
- Unique – multiple arm support options make for a unique device
- Compatibility – use with multiple head supports including Silverman and the standard head disc.

Optional Head Supports



REF: 11-220-05



REF: 11-229-09



SBRT Hand Grip Assembly

REF: 60-570

The SBRT Hand Grip Assembly allows for patient arm immobilization along their side. Comprised of a pair of comfortable hand grips that are indexed to the couch top with an integrated indexing system. There are 4 labeled positions for additional indexing flexibility. The modular style of the hand grips allow them to be attached or detached quickly and easily.



SBRT Knee Support

REF: 60-542

The SBRT Knee Support allows for the patient's knees to be lifted into a comfortable position. It is made of soft foam with a protective seal for easy cleaning and durability. The Leg Rest comes with an integrated indexing system with 4 labeled positions for additional indexing flexibility. Includes 3 risers for height adjustability.



SBRT Foot Support

REF: 60-552

The SBRT Foot Support allows for the patient's feet to be immobilized in a comfortable position. It is made of soft foam with a protective seal for easy cleaning and durability. The foot support comes with an integrated indexing system with 4 labeled positions for additional indexing flexibility. Includes 3 risers for height adjustability.



SBRT Lateral Pressure Indexing Bar

REF: 60-522

This Indexing Bar is the foundation of the system and it is the mechanism behind the direct to couch top fixation. The indexing bar along with two paddles make up the Lateral Pressure Positioning System. The lateral pressure provided is critical to reduce intra-fraction motion for SBRT treatments. The Crossbar system requires Lateral Paddles (REF: 60-525). Includes indexing module for both Varian Exact indexing or Elekta EVO couch top.



SBRT Lateral Pressure Paddle, Single

REF: 60-525

The SBRT Lateral Pressure Paddle allows for side pressure on the patient, which is critical to reduce intra-fractional motion for SBRT treatments. The SBRT Side Pressure Paddles require the SBRT Lateral Pressure Indexing Bar (REF: 60-522).

Respiratory Compression Belt



The Aktina Respiratory Compression Belt is designed to effectively apply pressure and restrict movement due to the patient's respiratory cycle. The belt allows for the application of user-defined pressure and is adjustable. It is ideal for liver or lung treatments. The belt is available in small, medium, and large size to accommodate various patient waist sizes. It is made of a durable long-lasting polyester material and includes a removable strap. The Bulb and Gauge Kit accessory (Ref No. 60-320) is used for local (next-to-patient) or remote (outside the treatment room) control and monitoring of the belt pressure. The optional Remote Access Kit (Ref No. 60-330) allows the Respiratory Compression Belt to be controlled from outside the LINAC at the control console. The kit includes wall plates, 100' pneumatic tubing, and an extension tubing that allows the compression belt to be connected directly to the quick connect plate on the wall inside the treatment room.



Bulb-gauge Assembly

REF: 60-320

The bulb-gauge assembly easily attaches to the belt with quick-release connectors.



Technical Specifications

Range (patient waist size)	small 22" to 34" medium 30" to 40" large 42" to 50"
Belt Width	8.25"
Bladder Size	15" x 7.5" neoprene in expandable pouch
Material	Denier Polyester with PVC backing
Operating Range	0 to 100mmHG
Pressure Increments	2mmHg
Pressure Mechanism	Hand-held manual bulb
Latching Mechanism	Velcro
Release Valve	Two release valves: patient and therapist

Ordering Information

Part Number (REF)	Description
60-310	Small
60-311	Medium
60-312	Large
60-320	Bulb -gauge Assembly
60-330	Remote Access Kit

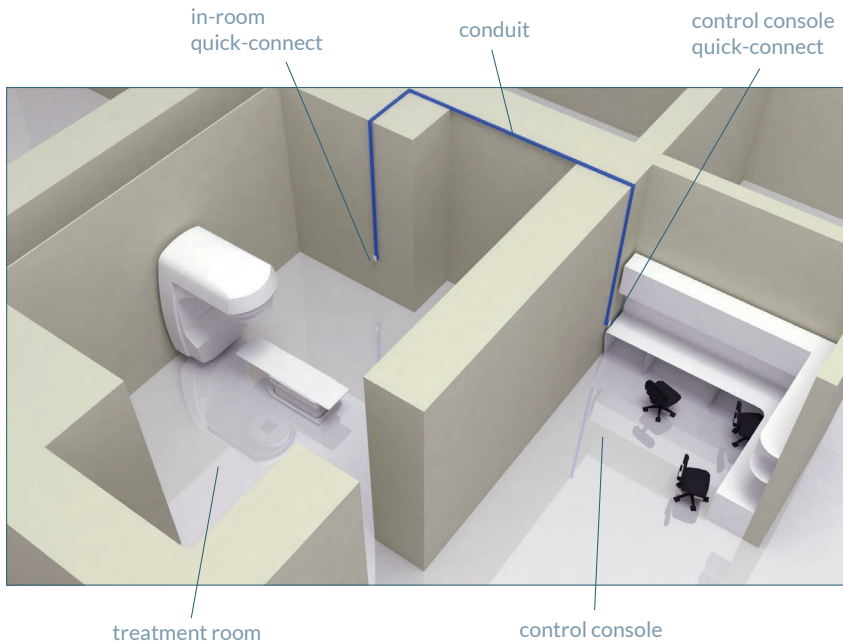

Respiratory Compression Belt with removable strap.



Respiratory Compression Belt without shoulder strap.

Remote Access Kit

REF: 60-330

The Remote Access Kit allows the Aktina Respiratory Compression Belt to be controlled from outside the LINAC at the control console. It includes wall plates and 100' pneumatic tubing. It also includes an extension tubing (to be modified to the correct length by the user) that allows the compression belt to be connected directly to the quick connect plate on the wall inside the treatment room. This allows the belt to be conveniently used without running tubes beneath the treatment door.

Maximum Run Distance	inside treatment room to treatment console	100' (30.5m)
Maximum Extension	inside treatment room wall box to patient on the treatment table	20' (6.1m)
Required Hardware (not supplied with system)	Standard single-gang utility box (quantity 2) Raceway or conduit from treatment console to inside treatment room	

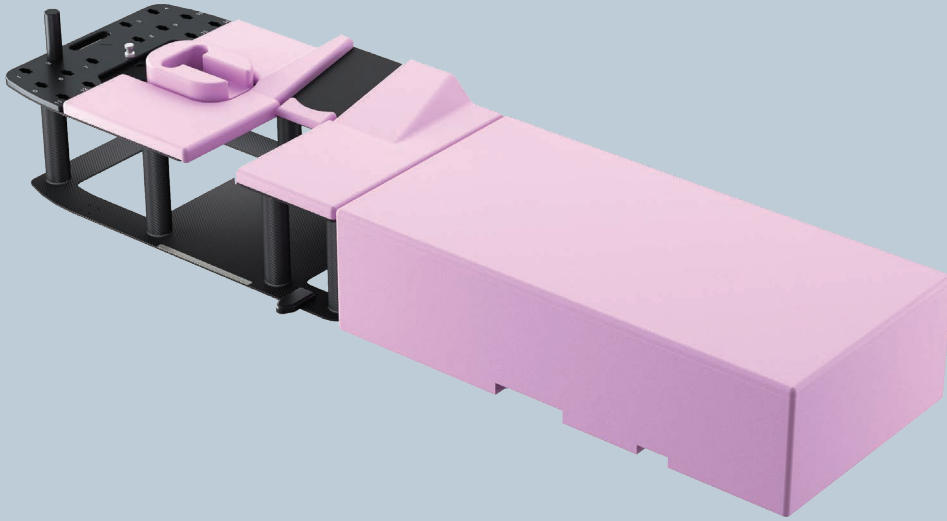

The Aktina SenoView was designed with the comfort philosophy in mind. Comfort is critical to the success of prone breast treatments. With the SenoView the patient can relax and not feel unbalanced or stressed. Built on a robust carbon fiber platform, the SenoView can handle extreme workloads while remaining light weight. A modular design coupled with a movable breast treatment window make for easy and accurate setups.

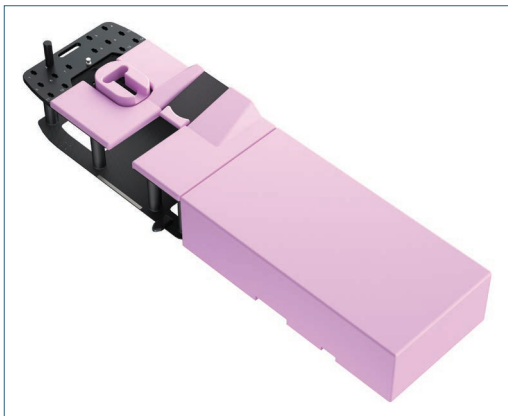

Alt View
REF: 70-210



Wall Mount
REF: 70-210

Simple and Easy to Use

The Aktina SenoView is comprised of 2 modular light-weight components that interlock to each other within seconds. Integrated indexing allows the unit to be fixed quickly to any treatment couch for a a secure treatment experience.

Reproducibility

A variety of setup options allow for precise reproducibility. This combined with the high comfort level of the design allow the patient to remain still for longer treatment times.

Storage

A wall docking station is available to safely store the components when not in use.

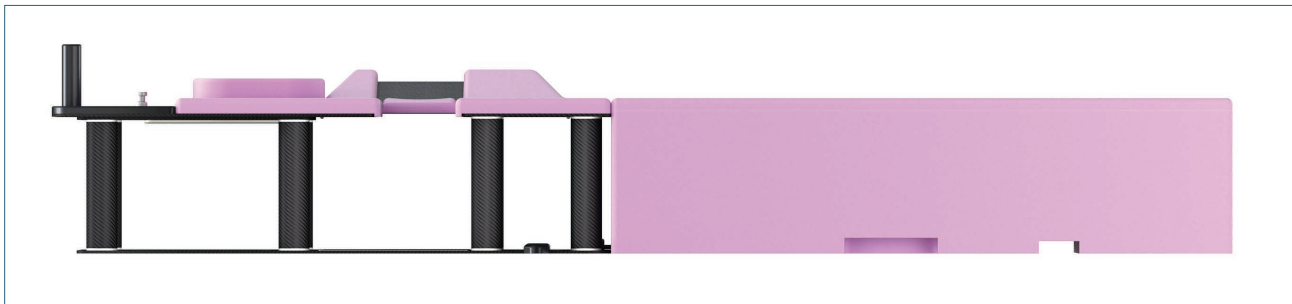

Side View
REF: 70-210

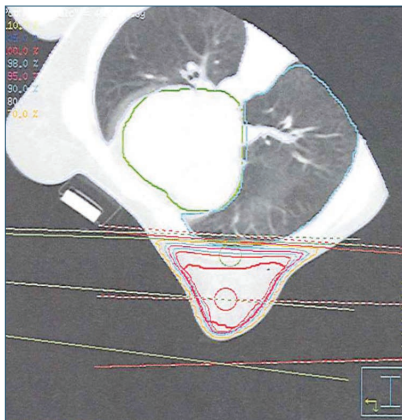

Clinical SenoView setup showing medial and lateral treatment fields for normal size breast.

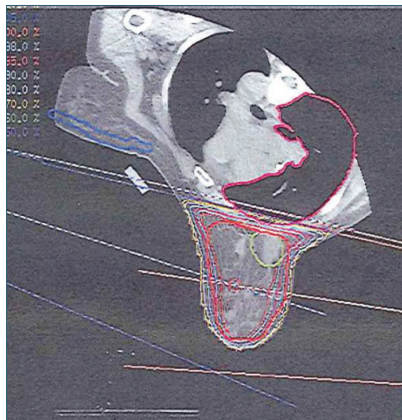

SenoView clinical treatment fields for pendulous breast.

The SenoView Advantage

With SenoView, the patient's anatomy is clearly visible without any obstructions, either by the device itself or the opposing breast. This allows for exceptional flexibility during treatment planning, where the dosimetrist can optimize the plan without any concern for avoiding carbon fiber components or the opposing breast.

The SenoView System was co-developed with Andrew J. Tamas, the Chief Radiation Therapist at Union State Bank Cancer Center. To learn more about the history of the SenoView System, please visit aktina.com.

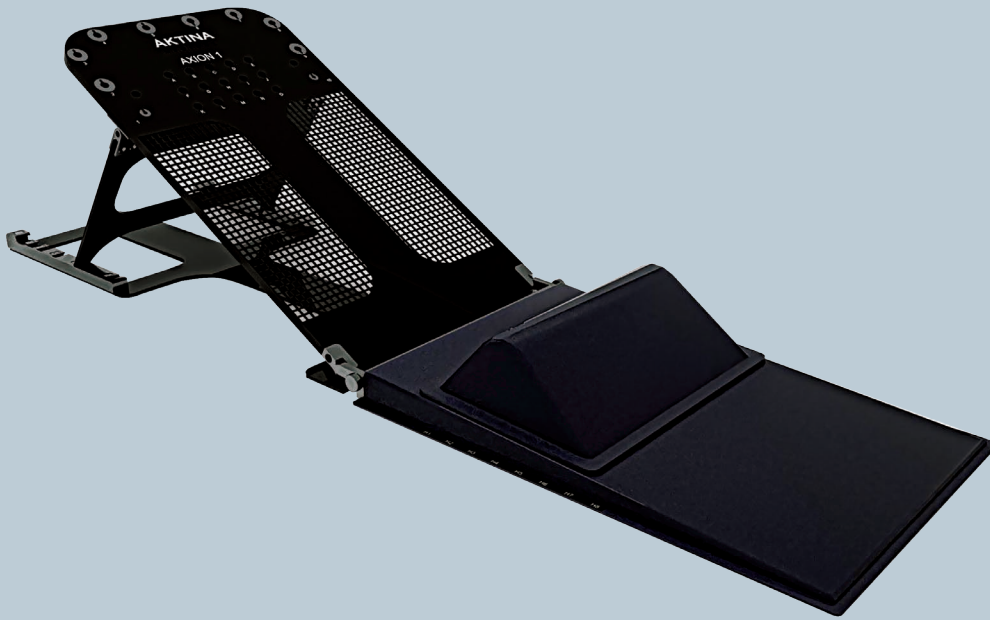

This AXION 1 Tilt Board provides superb patient setup and immobilization for breast treatments. It is fully indexable, so that all the setup options can be recorded and easily repositioned for efficient patient treatments. It comes standard with a removable Hip-Stopper which provides a comfortable means for ensuring the patient is positioned properly along the length of the device. Light-weight and easy to transport, it fits easily within the smallest CT scanner bores.

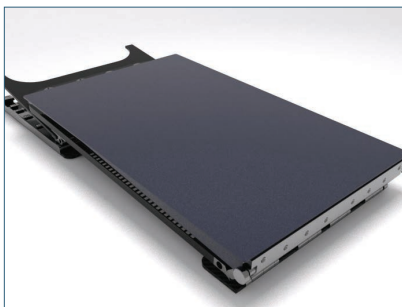

REF: 11-229

The Axion 1 conveniently folds onto itself for storage and transport.

Technical Specifications

Fixed Angles	0°, 10°, 15°, 20°, 25°, 30°, & 35°
Weight (tilt board)	13 lbs (5.9kg)
Weight (hip-stopper)	8 lbs (3.6kg)
Indexing Standard	2-pin indexing system
Mesh Size	16-1/8" × 6-1/2" (41cm × 16.5cm)
Attenuation	0.5mm Al equivalence (at 100kVp photon energy)
Mesh Dimension	Width: 6-9/16" Length: 16-1/8"
Board Dimensions	17" (43.2cm) Wide x 30-1/8" (76.5cm) Long
Maximum Loads	Evenly distributed: 220 lbs (100kg) End load: 110 lbs (50kg) Mesh area: 165 lbs (75kg)

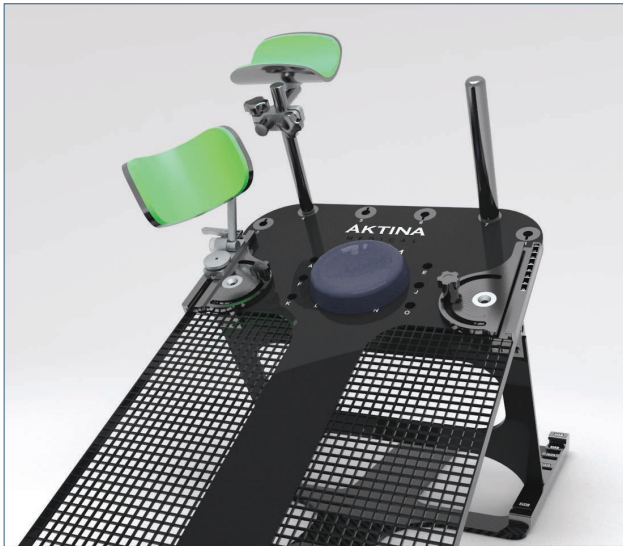

Arm Positioning Kit

REF: 11-230

This Arm Positioning Kit can be easily attached to the Axion 1 Breast Board (REF: 11-229). It contains a set of 3 arm positioning devices: an articulated padded triceps support, a wrist support, and a hand grip. All supports are fully indexed for easy and accurate setup. Use either the Arm Positioning Kit, or the Arm Cradle (REF: 11-231-S) with the Axion1 to setup and immobilize the patient's arms.



The Axion 1 can be utilized with different arm positioning options to allow for maximum clearance and clinical flexibility on any LINAC.

It's elegant design and low profile minimizes collisions and CT bore clearance issues.



Y Handles

REF: 60-812



Vertical Handles

REF: 60-812

Optional Head Supports



REF: 11-220-05



REF: 11-229-09



The controlled breath-hold provides superior method for managing respiratory motion.

The Elekta ABC measures tidal flow with a spirometer and displays the patient's respiratory curve on a monitor both in the treatment and control room. At the indicated inspirational tidal volume, a balloon valve is inflated, blocking airflow for a predetermined duration. The result is a repeatable breath hold, taken with the same volume every time. The operator irradiates during this breath hold, thus essentially freezing a moving target to achieve better conformance. The clinician and patient predetermine the duration and volume of the breath hold based on each patient's condition. This data is saved in the system as a patient specific file.

References

1. Wilson E.M., Williams F.J., Lyn B.E. et al. Validation of Active Breathing Control in patient with non small cell lung cancer to be treated with Chartwell. Int J Radiat Oncol Biol Phys. Vol. 57, No. 1, pp.864 – 874 (2003).
2. Wong J.W., et al. The Use of Active Breathing Control (ABC) to Reduce Margin for Breathing Motion. Int J Radiat Oncol Biol Phys. Vol. 44, No. 4, pp.911– 919, (1999).
3. Stromberg J.S., Sharpe M.B., Kim L.H., Kini V.R., Jaffray D.A., Martines A.A. and Wong J. Active Breathing Control(ABC) for Hodgkins's Disease: Reduction in Normal Tissue Irradiation with Deep Inspiration and Implications for Treatment. Int J Radiat Oncol Biol Phys. Vol. 48, No. 3, pp.797– 806, (2000).
4. Remouchamps V., Letts N., Vicini F. et al. Initial Clinical Experience with moderate deep inspirational breath hold using an Active Breathing Control device in the treatment of patients with left-sided breast cancer using external beam radiation therapy. Int J Radiat Oncol Biol Phys. Vol. 56, No. 1, pp.704 – 715 (2003).
5. Sixel K.E., Aznar M.C., Ung Y.C. Deep Inspiration Breath Hold to Reduce Irradiated Heart Volume in Breast Cancer Patients. Int J Radiat Oncol Biol Phys. Vol. 49, No. 1, pp.199 – 204 (2001).



Elekta ABC

- Universal system can be used on any LINAC, CT, or simulator.
- Patient feedback system allows the patient to monitor their respiratory cycle and improve patient compliance.
- Items in direct contact with the patient are one-time-use, so maintenance and cleaning are minimized.
- The system is completely customizable to patient capability for breath-hold duration and magnitude.
- Select inhalation or exhalation depending on treatment site.
- Patient thumbswitch allows patient to over-ride breath-hold.
- Countdown window in the treatment room gives patient clear feedback.
- Record patient respiratory history for post-treatment review.

The ABC transport system's elegant integrated design allows for shared use of the ABC between treatment and imaging rooms.

Elekta ABC Accessories

Aktina provides a range of accessories and add-ons to the Elektra ABC that improve the ABC's functionality and ease-of-use.

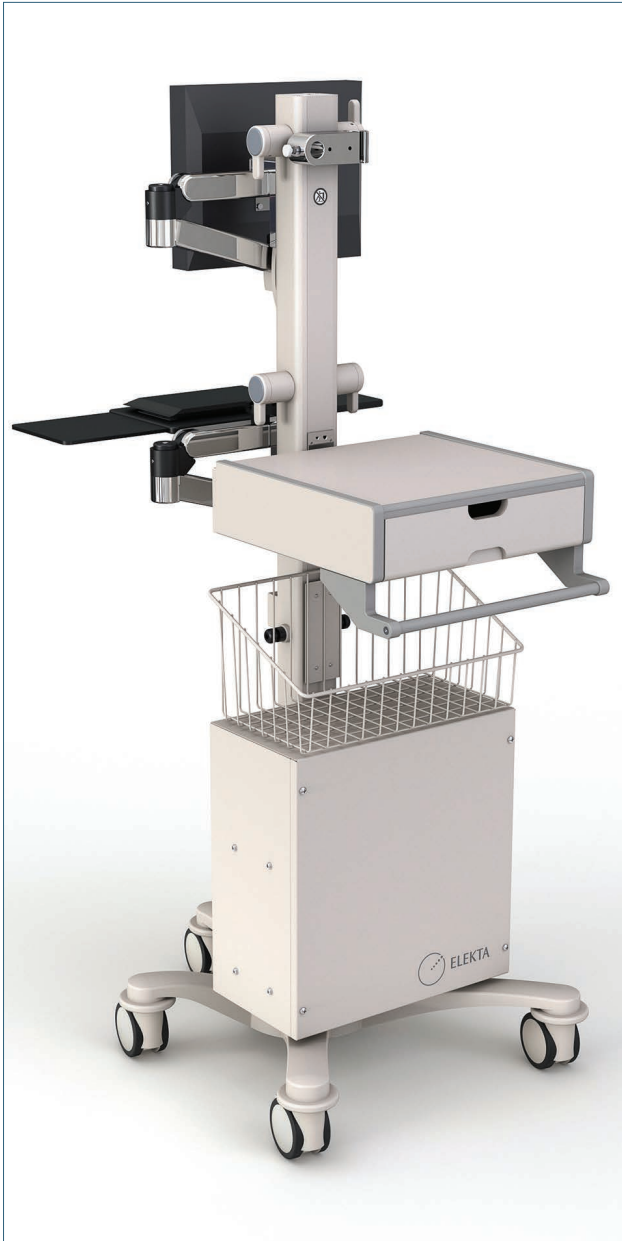

ABC Transport System

The ABC Transport System will allow fully functional ABC to be transported between imaging, treatment, and coaching rooms. It has a wide variety of benefits including integrated KVM extender, IEX power distribution, VGA goggle output, storage area for mouthpieces, cable management, and a docking station for the new Turbine enclosure.

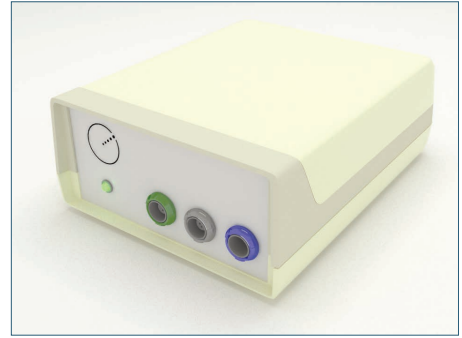

ABC Control Module

The ABC Control Module has been redesigned to improve reliability and usability. Improvements include changing communication interface to USB from RS-232, strain-relief connectors with quick-release mechanisms, relocation of connector ports to front panel to improve ease-of-use, and provide an overall reduction in size to minimize space requirements.



Spirometry Enclosure

A turbine casing has been introduced that protects all the ABC measurement hardware. This casing completely encapsulates the balloon valve as well so that the ABC equipment can be located in close proximity to the patient without the possibility of damaging sensitive components.



Mouthpiece Support Options

The ABC will now have multiple solutions for positioning the mouthpiece and ABC measurement components in close proximity to the patient. This array of solutions will include options for CT scanners, full body immobilization systems, breast boards, linac couch rail mounts, and elastic belts connecting directly to the patient.

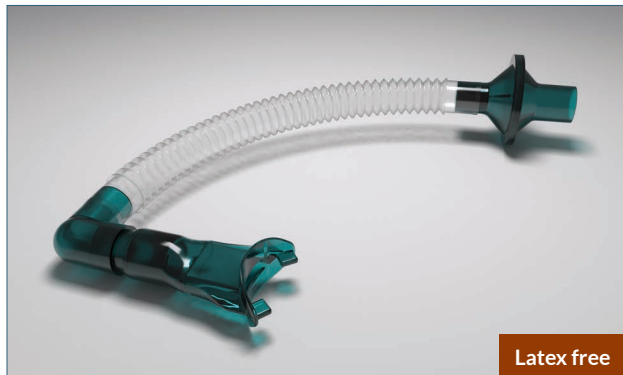

ABC Mouthpiece and Filter Kit

REF: 11-200-08-01

The Mouthpiece and Filter Kit is constantly evolving and the newest generation of ABC mouthpiece has benefited from this philosophy with optimal comfort and flexibility. The ABC mouthpieces are supplied in sets of 20. Each mouthpiece comes individually packaged and is a one-time use item that should be replaced between treatments. It comes with a filter, nose slips, mouthpiece and tubing.



ABC Control Switch

REF: 12-200-03

The ABC Control Switch connects directly to the ABC R3.0 Control Module. It allows the patient to enable or disable the ABC breath-hold.

This is a field replacement unit for the Elekta Active Breathing Coordinator R3.0.



ABC Sensor Enclosure Assembly

REF: 12-200-04

The ABC Sensor Enclosure Assembly includes a fully assembled spirometry system with balloon valve and protective covers. It is easily and instantly swapped in for a faulty unit. It connects directly on one side to the ABC R3.0 Control Module and the other side connects to the mouthpiece and filter kit.

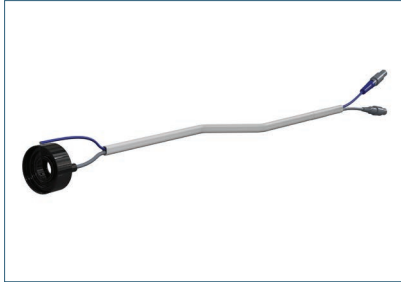

Sensor Pneumatics Cable Assembly

REF: 12-200-05

The Sensor Pneumatics Cable Assembly is a subsystem of the ABC Sensor Enclosure Assembly. It includes the transducer assembly and balloon valve tubing (balloon valve is not included in this replacement part). Hardware is not included as well.

This is a field replacement unit for the Elekta Active Breathing Coordinator R3.0.



Balloon Valve

REF: 12-200-06

The balloon valve is connected to the ABC respiratory circuit and is responsible for stopping the volume flow at the start of a breath-hold. The ABC user manual should be followed carefully for proper cleaning and maintenance.

This is a field replacement unit for the Elekta Active Breathing Coordinator R3.0.



Table Clamp

REF: 12-200-07-10

The Table Clamp allows either the Flexible Positioning Arm or the ABC Sensor Enclosure Assembly to be positioned in close proximity to the patient.

This is a field replacement unit for the Elekta Active Breathing Coordinator R3.0.



Flexible Positioning Arm

REF: 12-200-07-30

The Flexible Positioning Arm is an articulating extension that allows the ABC R3.0 Spirometry system to be located in close proximity to the patient.

This is a field replacement unit for the Elekta Active Breathing Coordinator R3.0.



Suction Cup Mounting Assembly

REF: 12-200-07-20

The Suction Cup Mounting Assembly allows either the Flexible Positioning Arm or the ABC Sensor Enclosure Assembly to be positioned in close proximity to the patient. It requires a flat smooth surface for suction cup to function properly.

This is a field replacement unit for the Elekta Active Breathing Coordinator R3.0.

Elekta ABC Legacy Accessories

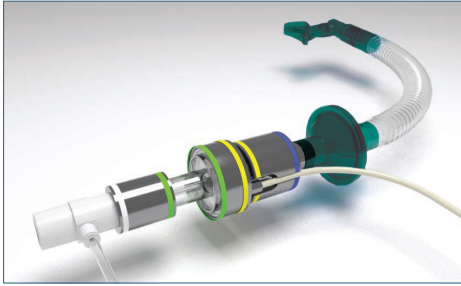

ABC Mouthpiece Assembly



Balloon Valve

REF: 11-200-08-05

The Balloon Valve is connected to the ABC respiratory circuit and is responsible for stopping the volume flow at the start of a breath-hold.

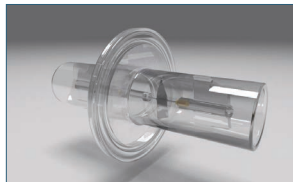

Turbine Cartridge

REF: 11-200-08-02

The Turbine Cartridge is a critical component for volume flow measurements. The unit is comprised of a turbine within a plastic shell that responds to bi-directional flow. It interfaces to the ABC Pick-Up Assembly (REF: 11-200-08-03).



Pick-Up Assembly

REF: 11-200-08-03

The ABC Pick-Up Assembly interfaces to the Turbine Cartridge (REF: 11-200-08-02) and detects volume direction and amount. It has a 2m cable that connects directly to the ABC Control Module.

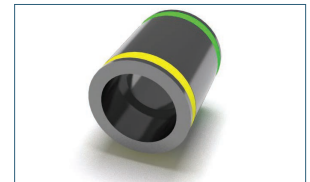

Balloon Coupler

REF: 11-200-08-04

The ABC Balloon Valve-Turbine Connector is used to connect the ABC Balloon Valve to the ABC Turbine assembly. It is color coded for easy assembly and sold in packs of 3.



Patient Switch

REF: 11-200-08-07

The ABC Control Switch connects directly to the ABC Control Module. It allows the patient to enable or disable the ABC breath-hold.



PC Extender

REF: 11-200-08-06S

The PC Extender allows the ABC control laptop (outside the treatment room) to communicate with the ABC Module (inside the treatment room). The system comes with a transmitter and receiver. It accommodates both VGA and serial communication over TCP/IP (CAT5 cable with RJ45 connectors).



ABC Control Laptop

REF: 11-200-05

ABC Laptop is delivered with the ABC Control Software pre-installed. The laptop usually is positioned outside the treatment room by the control console. It communicates with the ABC Control Module via a serial RS232 protocol that is transmitted over the PC extender (REF: 11-200-06).



Mouthpiece and Filter Kit

REF: 11-200-08-01

The ABC mouthpieces are supplied in sets of 20. Each mouthpiece comes individually packaged and is a one-time-use item that should be replaced between treatments. It comes with a filter, nose slips, mouthpiece and tubing.

SpiroCheck Duo



Quality Control for your Active Breathing Coordinator (ABC). Know exactly how your ABC is performing, each and every time.

SpiroCheck Duo is a completely automated quality assurance system for the Active Breathing Coordinator. It takes the uncertainty out of your ABC performance and provides unparalleled full system calibration within two minutes. Accurate to within 1.25%, you can rest assured knowing that you are providing the optimal patient care when utilizing the ABC unit for breath holds.

Advanced firmware and a known volume of air in the automated syringe are behind the simple pass/fail test result which is readily displayed on the integrated LCD screen. Calibrated volume displacement is 1 – 3 L. PC connectivity allows users to create and print QC reports. The SpiroCheck Duo is Compatible with ABC versions 2 and 3.



ABC Balloon Valve testing (shown to the left) is simple and accurate with the SpiroCheck Duo. The ABC Spirometry Enclosure docks into the balloon testing port on the SpiroCheck Duo. The balloon goes through a series of tests that assure the quality.

Spirometry testing (shown to the right) is done through the use of advanced firmware and a highly accurate aluminum piston. The known volume of air is pushed and pulled through the ABC Spirometry enclosure. The integrated computer code then processes the results for evaluation. Full ABC Spirometry QA is done in under 2 minutes.



The on-board LCD screen guides the user through the QA options which can be implemented with the push of a button. A newly revised menu and folder system now allow for baseline integration and data storage of each independent ABC system in your department. On screen graphics show which QA test is underway and the progress.



Softening Temperature

The thermoplastic masks will soften in about one minute at a temperature of 65°C / 149°F. The completely softened material becomes transparent, at which point it is ready to be modeled. An example of the transparency of softened material is shown below.

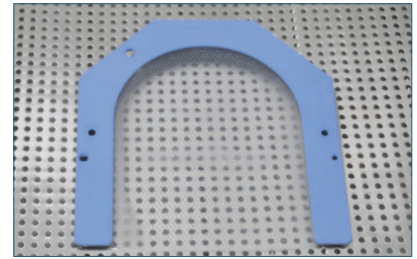

Modeling

A unique characteristic of the thermoplastic material is that it can be remodeled very easily. If remodeling is necessary for the same patient, the mask can be re-inserted into the water bath, at which point the heat activates the material and releases it so that it returns to its original form. This unique feature is extremely useful for remodeling an incorrectly formed mask or for adjusting a mask due to changing patient characteristics during the course of treatment. (Aktina does not recommend using the same mask for different patients).

Comfort

The thermoplastic composition is carefully chosen to have very specific contraction rates. Two formulas are used within the product line: one for head and neck products (88-92%) and one for chest and pelvis (90-95%). Experience has shown that the contraction force is small, so patients feel comfortable and the material models fixates well.

Thickness

Thermoplastic fixation is manufactured in four thicknesses: 1.6, 2.0, 2.4, and 3.0mm. The most commonly used thicknesses are 2.4 and 3.0mm.

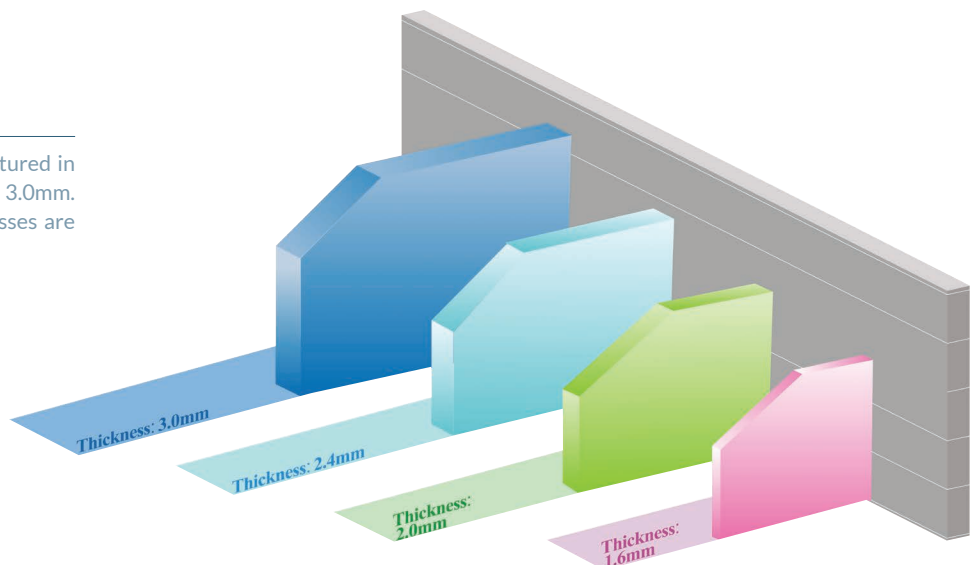

Essential Characteristics of Thermoplastic Masks



Handling and Hardening

Allow approximately 1-2 minutes to form the masks once they are removed from the water bath. The material will then become completely hardened at room temperature in 15-20 minutes.



Edge Style

In order to increase patient comfort, edges are reinforced by rounding the material.

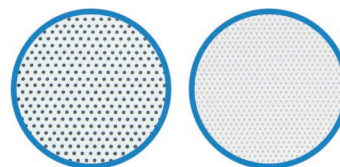

Aperture and Perforation

There are two diameters of apertures: 2mm and 3mm. 2mm aperture material achieves superior conformation to the skin surface than 3mm. There are also two perforation types: 22% and 36%. The thermoplastic material also comes in non-perforated.

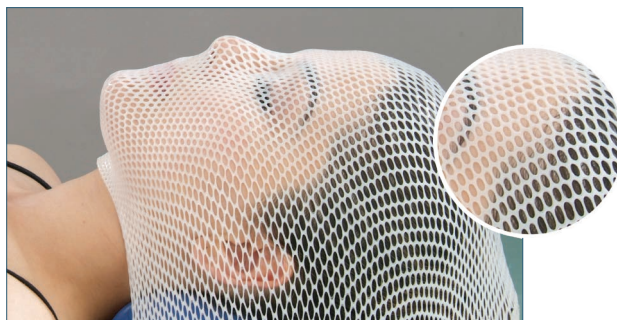

Non-Stick

The material surface is made of non-stick finish. During modeling, the material will not adhere to the patient's hair or skin. The technology used allows for this chemical non-stick property for up to two years.



During the molding operation for head masks, immobilization can be increased by applying slight pressure on the bridge of the nose for 3-5 seconds.

Thermoplastics



Head

There are 3 basic types of head immobilization masks:

- U-Shaped (use slide-over type connectors)
- S-Shaped (uses snap-in type connections)
- Triangular (uses L-type borders)

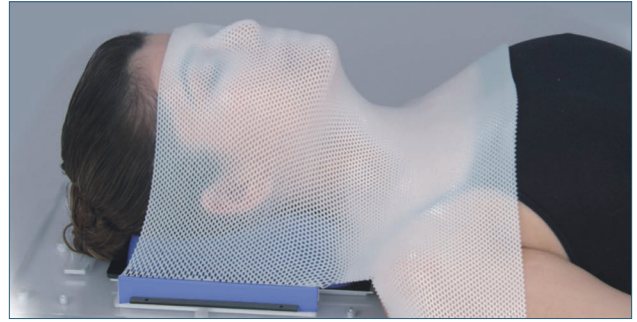

Neck and Shoulders

Neck and Shoulder masks are available with L-type borders.



Head, Neck and Shoulders

Two styles are available for this category:

- S-Shaped (uses snap-in type connections)
- L-type borders



Breast

Masks with L-type borders are available for the breast.



Chest-Pelvis

Chest-Pelvis masks are available with L-style borders.

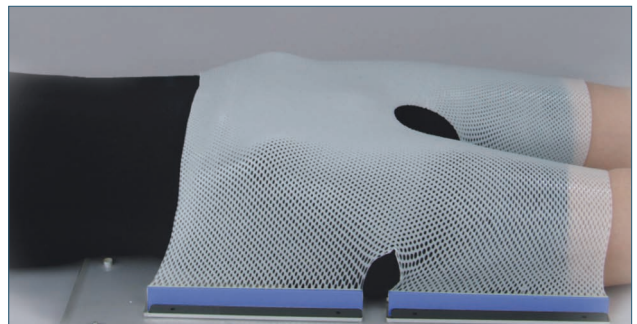

Pelvis

Masks with L-type borders are available for the pelvis.

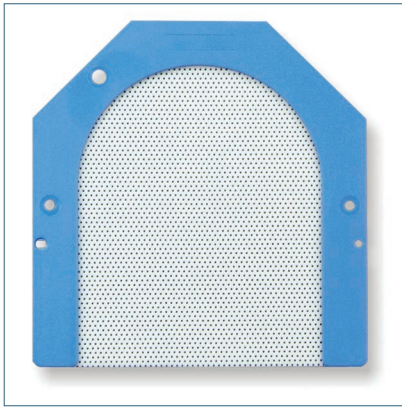

U-Shaped Head Mask

The U-Shaped Head Mask is one of the most commonly used masks for head immobilization. It is intended to connect to a base plate that has rotating clamp-style fixation tabs. The U-shaped mask can be quickly and easily detached from the patient.

Extended lengths of 5 and 9cm are available for increased coverage of the thermoplastic material.



Part Number (REF:)	Description	Thickness	Perforation	Additional Length
40-003	U-Shaped Mask	2.4mm	22%	n/a
40-013	U-Shaped Mask	2.4mm	22%	5cm
40-023	U-Shaped Mask	2.4mm	22%	9cm

Clamping Style Fixation



Triangular Head Mask

The Triangular Head Masks can be fixed to a base plate by means of hanging hook style connectors. This connection style is simple and easy to use, allowing for the patient to be rapidly removed from the fixation device. Some of the Triangular Masks also have a small opening for the nose, which allows the patient to breathe easier.



Part Number (REF:)	Description	Thickness	Perforation	Nose Opening
40-061	Triangular Head Mask	2.4mm	22%	no
40-062	Triangular Head Mask	2.4mm	22%	yes

Thermoplastics

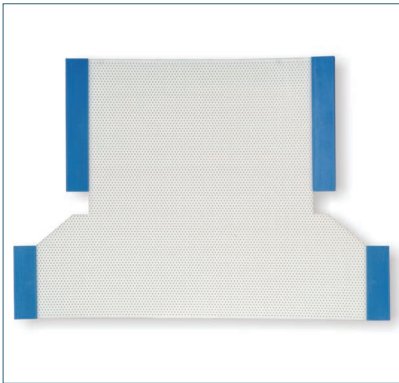

Neck-Shoulder Mask

The Neck and Shoulder Masks integrate into base plates that use the simple and effective hanging-hook style fixation mechanism. Nose holes are available for improved patient comfort and ease of mind.



Hanging-Hook
Style Fixation



Part Number (REF:)	Description	Thickness	Perforation	Nose Opening
40-101	Neck-Shoulder Mask (S)	2.4mm	22%	no
40-102	Neck-Shoulder Mask (S)	2.4mm	22%	yes
40-121	Neck-Shoulder Mask (L)	2.4mm	22%	no
40-122	Neck-Shoulder Mask (L)	2.4mm	22%	yes



Head-Neck-Shoulder Mask

The Head, Neck and Shoulder Masks integrate into base plates that use the simple and effective hanging hook style fixation mechanism. Nose holes are available for improved patient comfort and ease of mind.



Hanging-Hook
Style Fixation



Part Number (REF:)	Description	Thickness	Perforation	Nose Opening
40-201	Neck-Shoulder Mask (S)	2.4mm	22%	no
40-202	Neck-Shoulder Mask (S)	2.4mm	22%	yes
40-221	Neck-Shoulder Mask (L)	2.4mm	22%	no
40-222	Neck-Shoulder Mask (L)	2.4mm	22%	yes



S-Shaped Head Mask

The S-Shaped head mask uses quick-release expandable pins for locking the mask down to a base board. The mask is equipped with 5 locking bolts to increase the fixation of the mask to the base plate.



Expanding Style Fixation



Part Number (REF:)	Description	Thickness	Perforation	Additional Length
40-033	S-Shaped Head Mask	2.4mm	22%	n/a
40-043	S-Shaped Head Mask	2.4mm	22%	5cm
40-053	S-Shaped Head Mask	2.4mm	22%	9cm

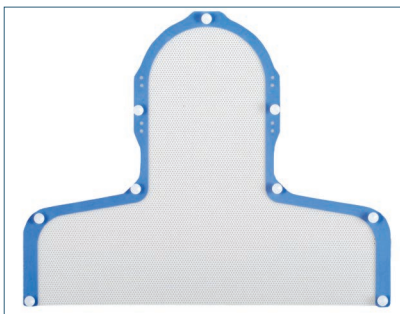

S-Shaped Head and Neck Mask

The Head and Neck Mask provides additional thermoplastic material in the shoulder area to provide a reproducible retraction of the shoulders away from the treatment field. Similar to the Head Mask, it uses quick-release expandable bolts for fixation to a base plate.



Expanding Style Fixation



Expanding Bolt

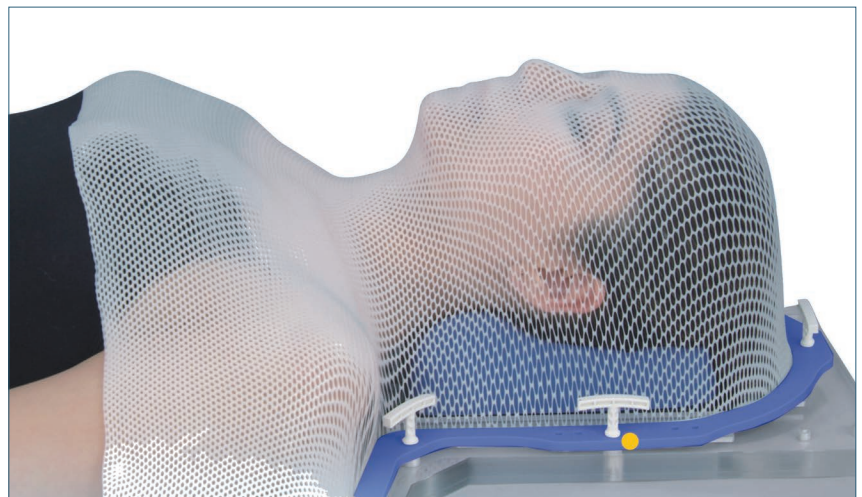

Part Number (REF:)	Description	Thickness	Perforation	Remarks
40-271	S-Shaped Head/Shoulder Mask	2.4mm	22%	Insert
40-275	S-Shaped Head/Shoulder Mask (S)	2.4mm	22%	Expanding bolts
40-278	S-Shaped Head/Shoulder Mask (M)	2.4mm	22%	Expanding bolts
40-281	S-Shaped Head/Shoulder Mask (L)	2.4mm	22%	Expanding bolts

Thermoplastics

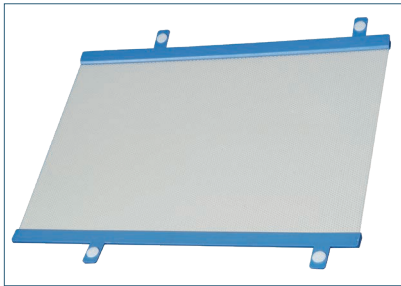

Pelvis-Thorax Mask

The Pelvis-Thorax mask accommodates a large area of the patient and is ideal for immobilization of the patient's midsection. The clamping style is unique and can be easily attached and detached from some of the more commonly found immobilization equipment in the industry.

Clamping Style
Fixation



Part Number (REF:)	Description	Thickness	Perforation	Remarks
40-611	Pelvis-Thorax Mask (M)	2.4mm	22%	Clamping style
40-621	Pelvis-Thorax Mask (L)	2.4mm	22%	Clamping style
40-641	Pelvis-Thorax Mask (M))	2.4mm	22%	Clamping style
40-651	Pelvis-Thorax Mask (L)	2.4mm	22%	Clamping style

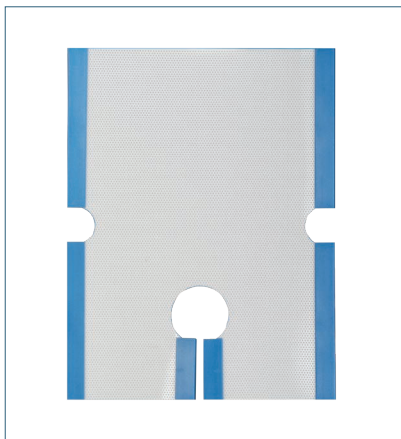

Pelvis Mask

The pelvis masks are ideal for prostate treatments. Six L-type hanging hook fixation brackets are provided to ensure adequate coverage and immobilization of the pelvis area. This mask provides cut-away areas to ensure that the thermoplastic material does not crumple or bulge in the folded areas.

Hanging-Hook
Style Fixation

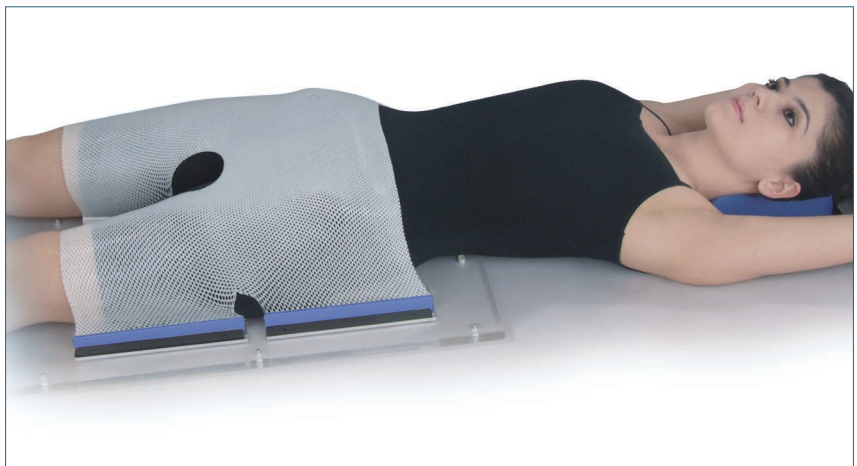

Part Number (REF:)	Description	Thickness	Perforation	Border Size
40-511	Pelvis Mask (M)	2.4mm	22%	230mm, 170mm
40-521	Pelvis Mask (L)	2.4mm	22%	230mm, 170mm
40-541	Pelvis Mask (M)	2.4mm	22%	245mm, 100mm
40-551	Pelvis Mask (L)	2.4mm	22%	245mm, 100mm



Water Bath Pan with Analog Controls

REF: SP-1600A

The SP-1600 series water bath is capable of handling large items. The SP-1600A water bath pan features a four-position hinged lid opening which is ideal when the unit is placed on a counter and below overhead cabinets. The SP-1600A has a manual thermostat for adjustments.

Technical Specifications

Material	Stainless steel
Dimensions	overall: 33" W x 26" L x 8" H (838 x 660 x 203mm) internal pan: 26" W x 22" L x 5" H (660 x 559 x 130mm)



Water Bath Pan with Digital Controls

REF: SP-1600D

The SP-1600 series water bath is capable of handling large items. The SP-1600D water bath pan features a four-position hinged lid opening which is ideal when the unit is placed on a counter and below overhead cabinets. The SP-1600D digital model delivers precise temperatures within +/- 1 degree.

Technical Specifications

Material	Stainless steel
Dimensions	overall: 33" W x 26" L x 8" H (838 x 660 x 203mm) internal pan: 26" W x 22" L x 5" H (660 x 559 x 130mm)





The AK550 Couch Top elegantly combines the needs for Image Guidance together with traditional requirements for patient setup flexibility. The rotational design allows for a large central opening on one side of the couch top, and side oblique beam openings on the other. Quickly and easily rotate the AK550 in between patients to increase patient throughput. The two-pin indexing system allows for accurate setup of surface mounted accessories in increments of 1cm along the full length of the couch top. Quick release components attach to either end of couch top. Stainless steel accessory rails can be attached and detached quickly on all 4 quadrants of the table.



Rotate the AK550 to choose the central opening or oblique side panels.

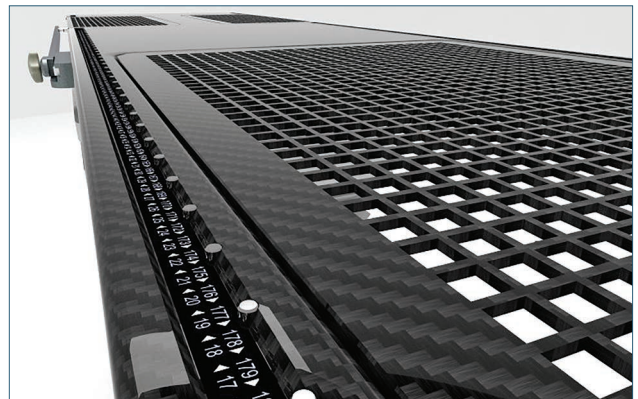

1cm indexing along the full length provides exceptional clinical flexibility.

REF: 51-201 AK550 Couch System Includes:

Qty	REF:	Description
1	51-200	AK550 CFTT
1	51-220	Extension Board, Carbon Fiber. Standard length.
1	51-230	Indexing bridge bar for AK550 Couch Top
1	51-250	Head and neck treatment panel.
1	11-216	Carbon Fiber mesh insert for the central opening.
2	11-218-L	Carbon Fiber mesh insert for the side openings.

LINAC Pedestal Adapters:

Qty	REF:	Description
1	51-205	Siemens AK550 Adapter
1	51-211	Varian AK550 Adapter
1	51-215	Elekta Precise AK550 Adapter
1	51-216	Elekta Pedestal AK550 Adapter

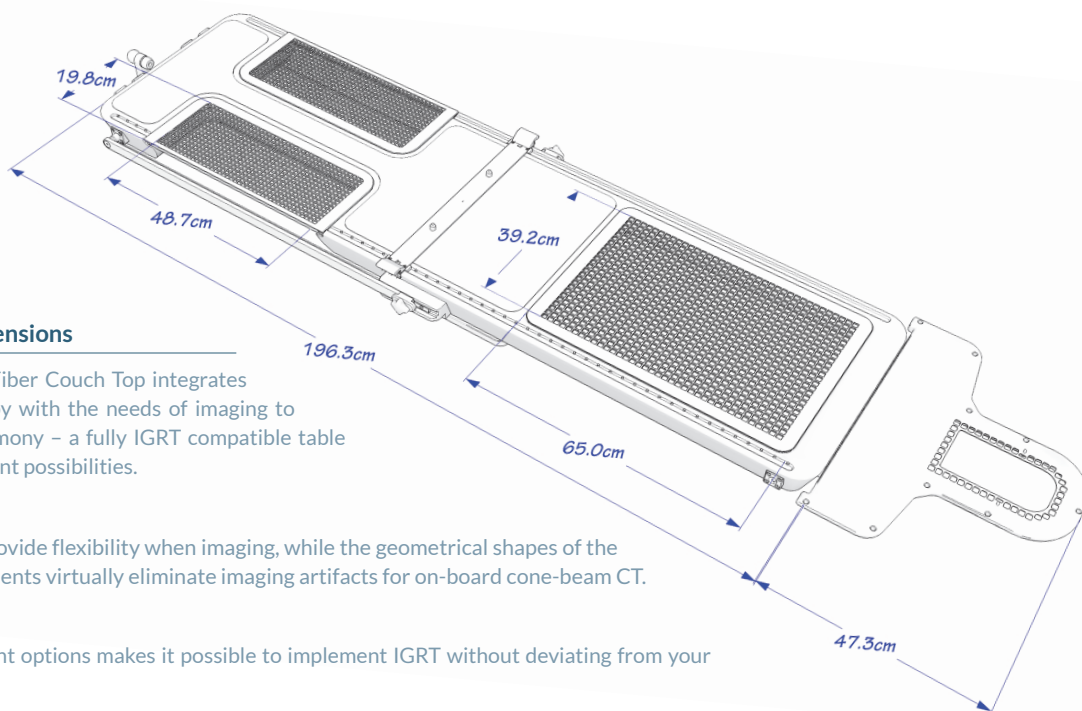

AK550 Overall Dimensions

The AK550™ Carbon Fiber Couch Top integrates the demands of therapy with the needs of imaging to create the perfect harmony – a fully IGRT compatible table with maximum treatment possibilities.

Imaging

Large imaging areas provide flexibility when imaging, while the geometrical shapes of the carbon fiber table elements virtually eliminate imaging artifacts for on-board cone-beam CT.

Treatment

The variety of treatment options makes it possible to implement IGRT without deviating from your normal patient setups.

Maximum Permissible Loads

Evenly Distributed Load – Entire Table	250kg (550 lbs)	Head and Neck Treatment Panel	10kg (22 lbs)
End-load – 15cm from Either End (without extension)	100kg (220 lbs)	Accessory Rail Load – Torque	7.5kg-m (54 ft-lb)
Central-opening Mesh Insert	100kg (220 lbs)	Accessory Rail Load – Vertical Load	68kg
Side-opening Mesh Insert	90kg (198 lbs)	Bridge Bar – Longitudinal Load	25kg
Extension Panel	50kg (110 lbs)	Bridge Bar – Torque Load	11.5kg-m

Deflection Characteristics

Applied Weight	Location of Weight	Table Deflection
105kg (231 lbs)	10cm from end of table (central insert side)	7.0mm
105kg (231 lbs)	10cm from end of table (oblique inserts side)	9.1mm



Head and Neck Extension: 5-point Mask

REF: 51-250

The Head and Neck Extension allows for patient immobilization with a 5-point mask for Head and Neck treatments. It quickly and easily snaps onto either end of the AK550 Couch Top via a self locking mechanism which does not allow for accidental removal. The carbon fiber shell provides low attenuation with excellent rigidity.

Technical Specifications

Weight	2.4kg (5.28 lbs)
Construction	Carbon Fiber with foam core
Rigidity	3.4mm deflection with 11.7kg (25.7 lbs) applied
Attenuation	0.8% for 6MV and 0.6% for 15MV
Treatable area	35cm from superior tip of loop
Head Supports	Aktina Silverman type



Carbon Fiber Extension Panel

REF: 51-220

The Extension Panel allows for patient setups when patient's head or feet extend over the end of treatment table. It quickly and easily snaps into place. The self-locking safety-latch does not allow for accidental removal.

Technical Specifications

Weight	3.6kg (7.9 lbs)
Material	Carbon Fiber with foam core
Maximum Load	50kg (110 lbs)
Dimensions	54cm wide × 35cm long (21.3" × 13.8")

Couch Tops, AK550 System

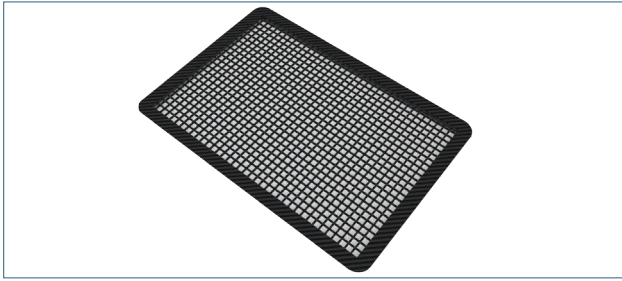

Carbon Fiber Mesh Insert. Central Opening.

REF: 11-216

This Carbon Fiber mesh inserts utilize pretensioned carbon fiber to provide excellent rigidity for patient setups, low radiation attenuation, and excellent skin-sparing characteristics. A mylar replacement kit is available for on-site mylar refurbishing.

Technical Specifications

Weight	1.3kg (2.8 lbs)
Construction	Carbon Fiber with foam core
Rigidity	4.5mm 20kg (44 lbs) load centrally located about 6 x 10cm area
Attenuation	6MV - Mesh: 1% Frame: 5% 15MV - Mesh: 0.5% Frame: 3.5%
Mesh Area	37cm x 19cm (14.6" x 7.5")
Protective Surface	Mylar

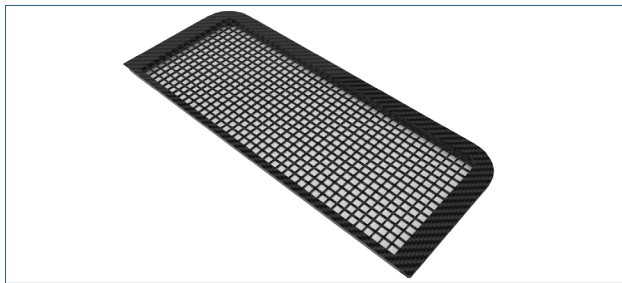

Oblique Carbon Fiber Insert

REF: 11-218-L

This Carbon Fiber Mesh Insert is compatible with AK550 table tops sold after April 2006. The carbon fiber mesh provides all the necessary skin sparing affects. A mylar replacement kit is available for on-site mylar refurbishing.

Technical Specifications

Dimensions	Length: 49cm Width: 19cm
Material	Carbon Fiber with foam core

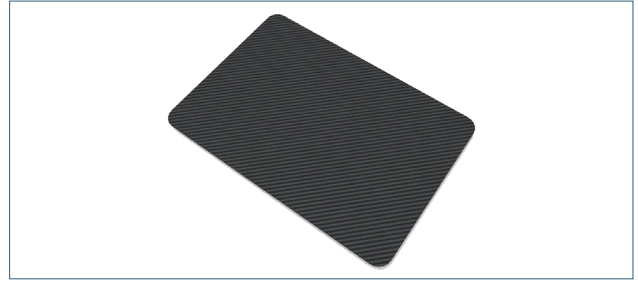

Carbon Fiber Solid Insert

REF: 11-216-S

The solid insert fits into the central opening of both the AK550 and IGRT Couch Top. It is constructed from thin carbon fiber shell and foam core. It's low attenuation and high rigidity characteristics are ideal for clinical treatments that require the least amount of imaging artifacts in the field during port film verification.

Technical Specification

Weight	0.7kg (1.5 lbs)
Construction	Carbon Fiber with foam core
Attenuation	6MV: less than 1%



Two Pin Indexing Bars

REF: 51-235

REF: 51-230

The indexing bridge bar is intended to snap into the Aktina AK550 Couch Top at predefined indexing positions (every 1cm). It uses a two-pin system for indexing table mounted accessories, such as Breast Boards.

This 1" wide version is narrower to accommodate various 3rd party patient immobilization accessories.

Technical Specifications

Compatibility	Aktina AK550 Indexing system with 1cm indexing
Bar Width	2.54cm (1.0") REF: 51-235 5.1cm (2.0") REF: 51-230
Two-Pin Spacing	22.9cm (9")
Couch Top Width	54cm (21.25")

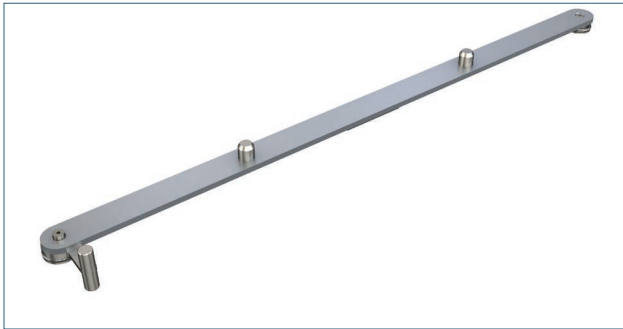

Twist Lock Indexing Bar for Exact™ Couch Top

REF: 51-237

Standard two pin indexing bar. Fits Exact type couch tops.

Twist Lock Indexing Bar for Exact™ Couch Top

REF: 51-237-M

Moves in the lateral direction for off-set positioning.

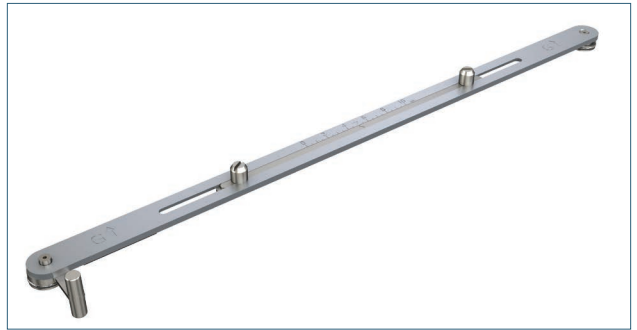

CT Therapy Imaging Overlays

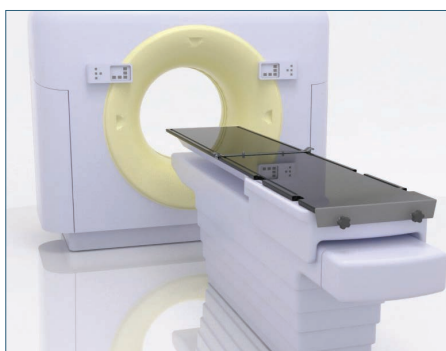
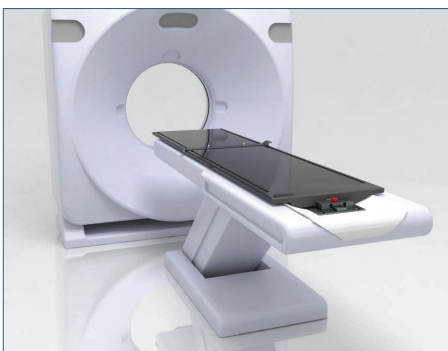
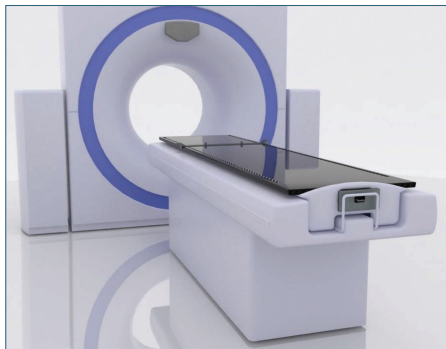
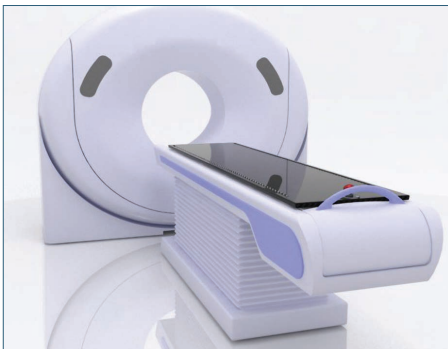

Aktina Medical provides a wide range of CT overlays for performing CT based treatment planning on a flat imaging surface. All the Aktina CT overlays are constructed from carbon fiber which eliminates any imaging artifacts. The overlays feature an indexing system which accommodates an industry standard 2-pin indexing bridge bar. This indexing system has 1cm increments for maximum flexibility.

Aktina has a number of CT overlays for different CT scanners from the following manufacturers:

- Toshiba
- Siemens
- Phillips
- GE

Please contact Aktina for the exact part number to match your CT Scanner.

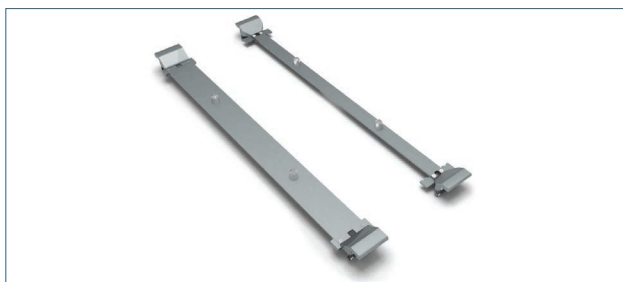

Indexing Bridge Bar for CT Overlays

REF: 51-231

The indexing bridge bar is intended to snap into the Aktina CT Overlays at predefined indexing positions (every 1cm). It uses a two pin system for indexing table mounted accessories (such as Breast Boards). The distance between the pins is the industry standard 9".

Technical Specifications

Compatibility	Aktina CT Overlays
Bar Width	4.08cm (2.0")
Two-Pin Spacing	22.9cm (9")
Couch Top Width	53cm (20.87")

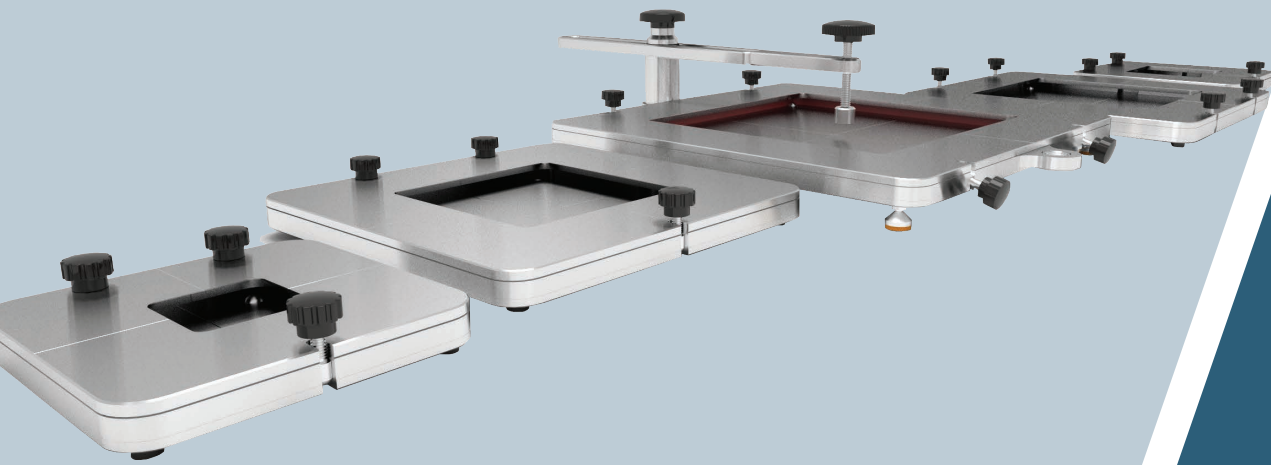

The Aktina Electron Beam Shaping System is used to fabricate custom low-melting alloy masks for electron treatments. The casted masks are used to collimate the electron beam applicators for the Elekta Linear accelerator. Aktina provides a full line of accessories to simplify electron mask fabrication.

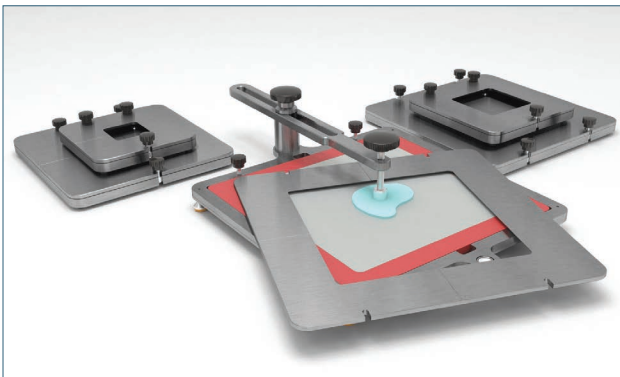

Standard Configuration

REF: 11-270

Used with standard Elekta LINACs with 5 electrons applicators, ranging from 6x6 through 25x25cm.

System consists of:

- Qty 1, REF: 11-268 – Casting and Leveling System
- Qty 1, REF: 53-046 – Hot Wire Cutter
- Qty 1, REF: 11-275 – Molding Inserts



Beam-modulator Configuration

REF: 11-269

Used with beam-modulator Elekta LINACs with 3 electrons applicators: 6x6, 10x10 and 6x10cm.

System consists of:

- Qty 1, REF: 11-267 Casting and Leveling System
- Qty 1, REF: 11-275-01 Rubber Mold Set

Electron Field Fabrication Accessories

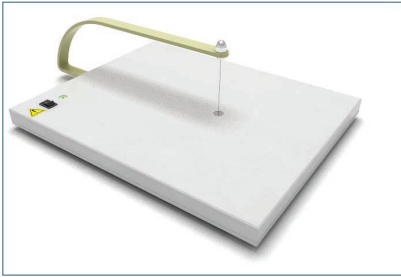

Hot Wire Cutter

REF: 53-046

The Hot Wire Cutter is used for cutting styrofoam precuts that can be used in Aktina Electron Beam Shaping molds. The shape of the cutout can be transferred to the styrofoam with the Aktina Electron Transparencies and the Acrylic Applicator Plates. Input power requirements are 110-220VAC, 50-60Hz. Region specific power cords can be ordered separately from Aktina.

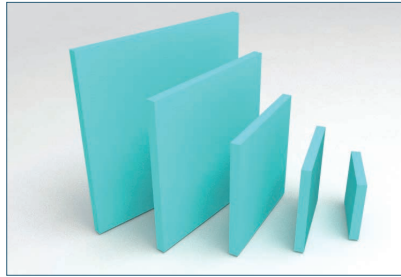

Styrofoam Precuts

REF: 11-272

The Styrofoam Precuts are used with the Aktina Electron Beam Shaping System. The field shape can be transferred to the Cutouts with the aid of the Aktina Electron Templates and the Electron Plates. The Aktina Electron Hot-Wire cutter is then used to create the correct shape that will then produce the opening in the cerrobend mask. The kit has 60 pieces in total, 12 for each applicator size. They are made from hi-density blue styrofoam, 9/16" thick.

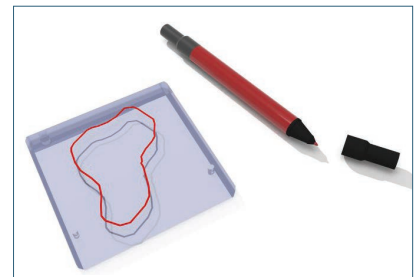

Electron Mask Templates

REF: 11-306

The set of 5 Aktina Acrylic Plates are used when creating templates of field shape contours for electron cutouts. The acrylic plate is placed into the applicator and it provides a hard clear surface to draw the contour on the transparency template. Each plate has the proper indents and grooves to clear the interlock switches and snugly fit into the latch of the Elekta applicator. The set includes 5 sizes, one for each electron applicator.

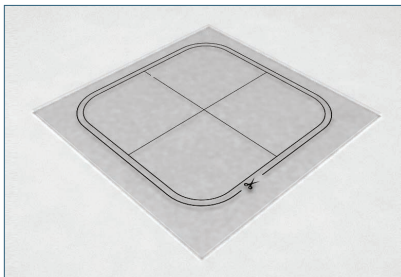

Electron Mask Transparencies

REF: 11-305

The Aktina Transparencies templates are intended to be used with the Beam Shaping system. They are used to transfer the field shape to a cerrobend mask. Clear acrylic plates, REF: 11-306, can be used as backing when drawing the field shape on the transparency.

Replacement Rubber Molds

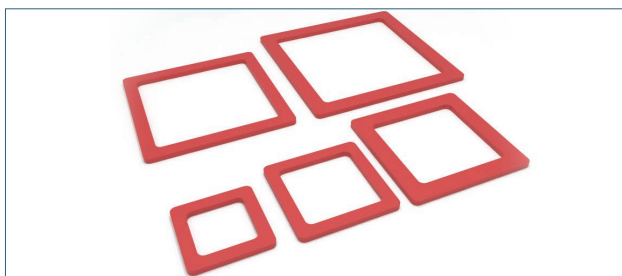

Electron Molds, Standard Kit

REF: 11-275

Set of 5 replacement rubber molds for electron applicator sizes: 6x6, 10x10, 14x14, 20x20, and 25x25. The molds are manufactured from high-durometer rubber with a thickness of 0.375".

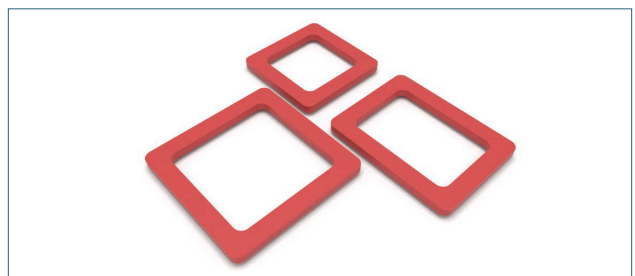

Electron Molds, Beam Modulator

REF: 11-275-01

Set of 3 replacement rubber molds for electron applicator sizes: 6x6, 10x10, and 6x10. The molds are manufactured from high-durometer rubber with a thickness of 0.375".

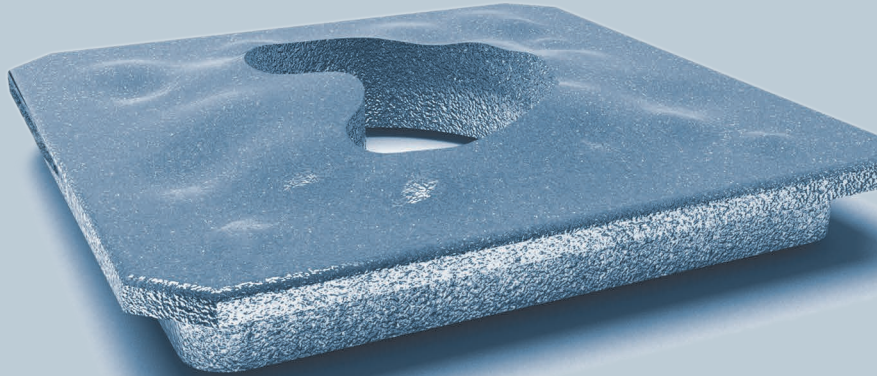

The Aktina Electron Beam Shaping System is used to fabricate custom low-melting alloy masks for electron treatments. The casted masks are used to collimate the electron beam of the 95cm applicators for the Siemens Linear accelerator. Aktina provides a full line of accessories to simplify electron mask fabrication.

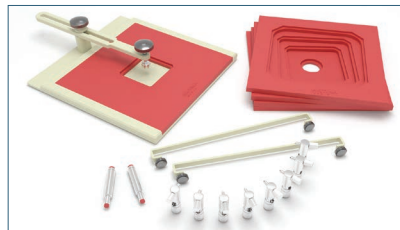

Siemens Electron Beam Shaping System

REF: 52-626

System Components:

- REF: 52-914 Shaping Base (1 piece)
- REF: 53-050 Rubber Mold Set (1 set)
- REF: 35-960 Cerrobond Bracket (2 pieces)
- REF: 35-965 Cerrobond Stiffener (2 pieces)
- REF: 35-969 Cerrobond Clamp (8 pieces)
- REF: 52-923 Sytrofoam Precuts (1 set)
- REF: 53-046 Hot Wire Cutter (1 piece)

Additional Accessories



Cerrobond Alloy

REF: 99-229

The Cerrobond Low Melting Alloy has a melting temperature of 203° F and is cadmium free.

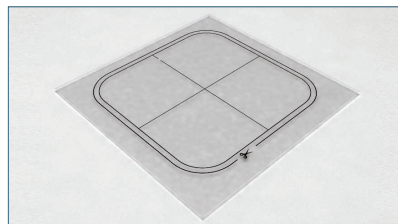

Electron Transparencies

REF: 53-459

The Aktina Transparencies templates are used to transfer the field shape to a cerrobond mask. They can be used with clear acrylic plates, REF: 53-460, which fit into the applicator and can be used as backing when drawing the field shape on the transparency.



Applicator Plates

REF: 53-460

The Electron Applicator Plates are used when creating templates of field shape contours for electron cutouts. The acrylic plate fits into the applicator and provides a hard clear surface to draw the contour on the transparency template.

Electron Beam Shaping System Replacement Parts

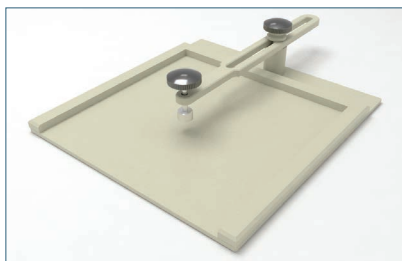

Shaping Base

REF: 52-914

The Electron Beam Shaping Base provides a platform for creating electron masks for the Siemens 95cm electron applicators. The Base has an adjustable arm which is used to secure Styrofoam cutouts within the rubber molds.



Rubber Mold Set

REF: 53-050

The Rubber Mold Kit includes five rubber molds, one for each electron applicator size. They are positioned in the molding base and create the proper outer dimensions of the cerrobend mask for each applicator size.



Cerrobend Stiffener

REF: 35-965

The Cerrobend Stiffeners help secure the 25cm cerrobend mask while the gantry is rotating.



Cerrobend Brackets

REF: 35-960

The Cerrobend Bracket is used to secure the 25x25cm cerrobend mask to the underside of the applicators.



Cerrobend Clamps

REF: 35-969

The Cerrobend Clamp attaches on the side posts of the applicator body applying pressure downwards onto the electron mask, helping secure the cerrobend mask in place.

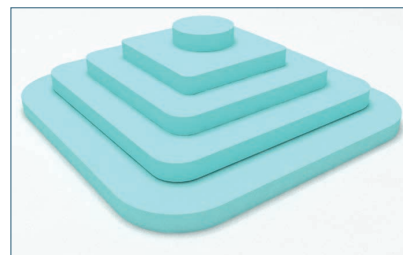

Styrofoam Precuts

REF: 52-923

The Styrofoam Precuts are used to create the patient's field shape within the cerrobend mask. They can be cut to the proper field shape with the use of the Hot Wire Cutter. The kit has 60 pieces in total, 12 for each applicator size.

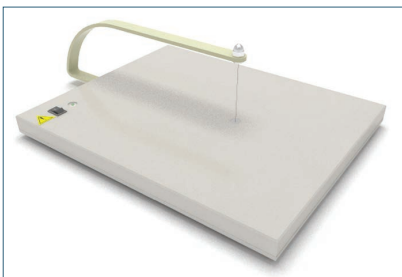

Hot Wire Cutter

REF: 53-046

The Hot Wire Cutter is used for cutting styrofoam precuts that can be used in Aktina Electron Beam Shaping molds.

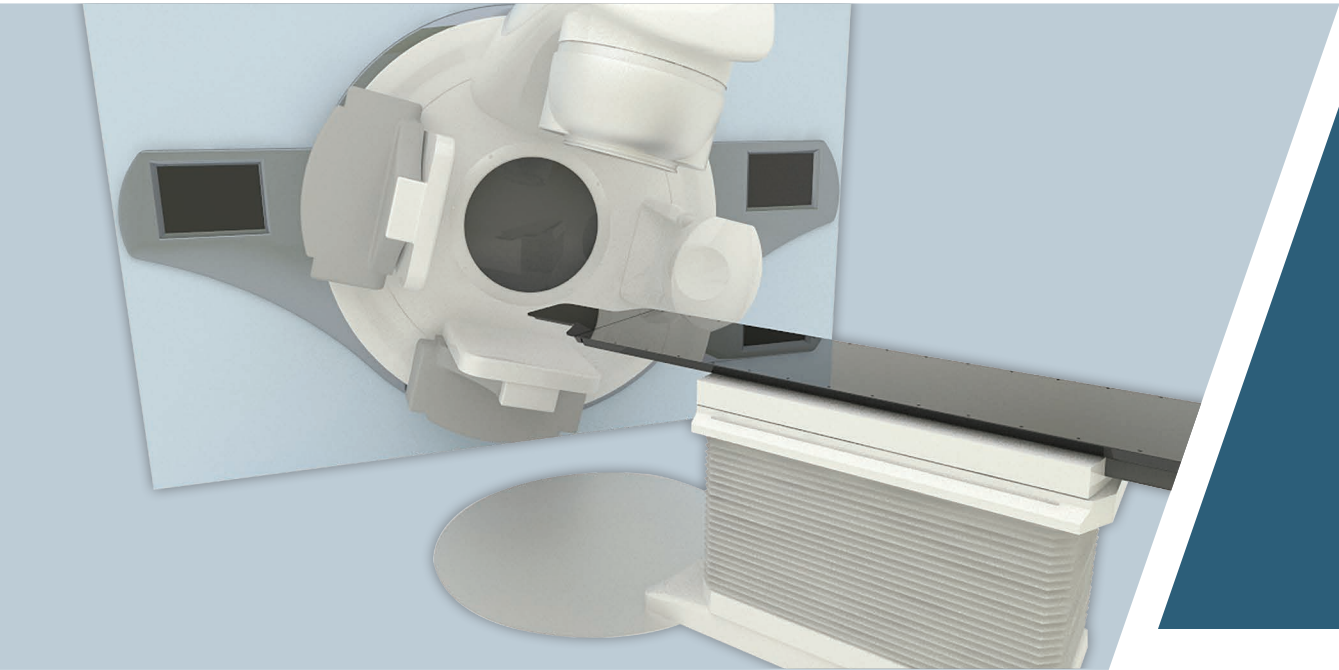

- Mechanical front pointers
- Port film graticules
- Electron beam shaping systems
- Cassette holders
- Model LINAC
- Area monitors
- Wedge filters
- Beam block trays
- Lead block systems
- LAP lasers

Mechanical Front Pointers

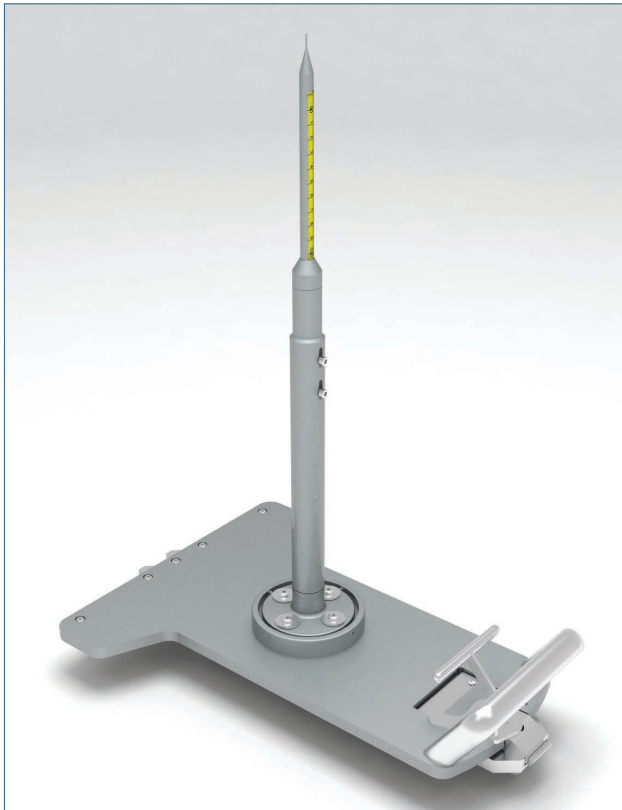

REF: 11-360 - Elekta Compatible

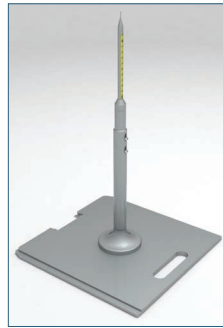

REF: 53-104 - Siemens Compatible

The unique Aktina Mechanical Front Pointer designs simplify LINAC monthly and annual QC tests. The high-precision tip is critical for the required acceptance and annual QC testing. A simple calibration method allows for adjustment of the tip position in all three X, Y and Z directions.



Mechanical Front Pointers



X-Y Calibration Mechanism



Z Calibration Mechanism

	Elekta	Siemens
Compatibility	Elekta LINAC	Siemens 80MLC
Interface	Direct Mount to collimator face	Beam block tray slot
Range	90 - 110cm SSD	90 - 110cm SSD
Electrical Interface	Interlock bypass (can deliver radiation)	Code: POINT
Tip Size	1.5mm diameter cylinder	1.5mm diameter cylinder
Calibration	Along pointer axis: 10mm range Perpendicular to axis: 5mm range	Along pointer axis: 10mm range Perpendicular to axis: 5mm range

Not for sale in Europe.

The Elekta Graticules facilitate patient localization within the radiation field.

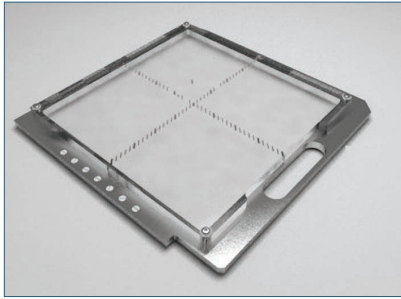

Elekta Standard Graticule

REF: 11-345

The Standard Elekta Graticule attaches to the Elekta Short Shadow tray holder removable accessory. The diverging tungsten attenuators imbedded in a clear acrylic frame provide a crisp, clear image for port film evaluation. It is meant to be removed during treatment. This Graticule is not compatible with the Elekta Standard Shadow Tray Holder.

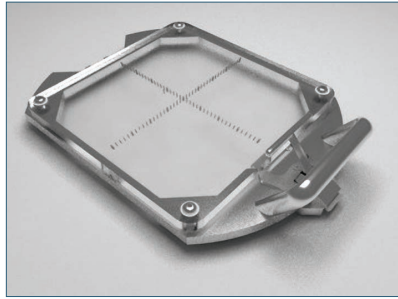

Elekta Direct Mount Graticule

REF: 11-344

The Direct Mount Graticule mounts directly to the head of the Elekta LINAC, which is ideal for centers that exclusively use the MLC for field shaping, and do not utilize the Shadow Tray Holder. It has the identical diverging tungsten markers as the Standard Graticule. Unlike the Open Air Graticule, it must be removed for treatment. The Direct Mount graticule provides clearer port film images than the Open Air, and also has larger markers every 5th. A safety latch requires two-step motion to detach.

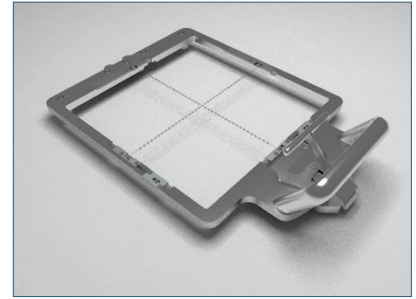

Elekta Open Air Graticule

REF: 11-346-M1

Similar to the Direct Mount graticule, the Open Air Graticule mounts directly to the head of the Elekta LINAC. It has small spherical markers which are spaced 1cm at iso-center. This Graticule can be left in the field for all photon treatments, which saves the therapist the time for entering and exiting the treatment room. A safety latch requires two-step motion to detach.

	Standard	Direct Mount	Open Air
Construction	Acrylic plate mounted metal anodized frame	Acrylic plate mounted metal anodized frame	Spherical markers on steel wire within open frame
Plate Material	0.5" acrylic	0.5" acrylic	None. Open air design.
Insert Location	Beam-block tray slot of the SHORT shadow tray holder	Inserts directly into the accelerator head	Inserts directly into the accelerator head
Attachment Mechanism	Slides into beam block tray slot	Two-step safety quick-release	Two-step safety quick-release
Weight	4.5 lbs	6.1 lbs	3 lbs
Marker Material	Tungsten	Tungsten	Lead
Marker Size at Isocenter	2mm (every cm) 4mm (every 5th cm)	2mm (every cm) 4mm (every 5th cm)	3.6mm
Marker Spacing (@ iso)	1cm	1cm	1cm
Marker Span (@ iso)	40 × 40cm	40 × 40cm	36 × 36cm
Coding	User selectable (Elekta beam block tray table 1 through 126)	Elekta Beam Block Tray 126	None
Orientation Marker	One off-diagonal marker allows for easy film orientation	One off-diagonal marker allows for easy film orientation	None
Marker Attenuation (water, 10cm depth, 100cm SAD)	Not applicable	Not applicable	6 MV: 2.5% 15 MV: 1.5%

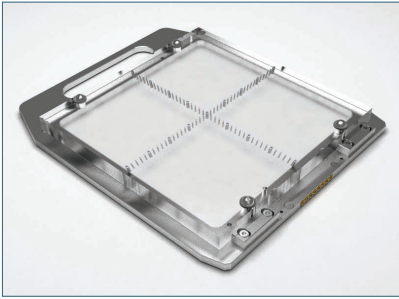

Standard Graticule

REF: 54-044

The Aktina Siemens Port Film Graticule projects a 1cm grid (at isocenter) for the purposes of port film verification. It fits into slot 2 of the Siemens MLC LINACs (pre-Artiste models) and can be adjusted up to $\pm 3\text{mm}$ to allow for alignment with the LINAC central axis. The unique design fixes the calibration robustly, eliminating the need for routine adjustments of grid position. An off-axis marker aids in film orientation on the light-box.

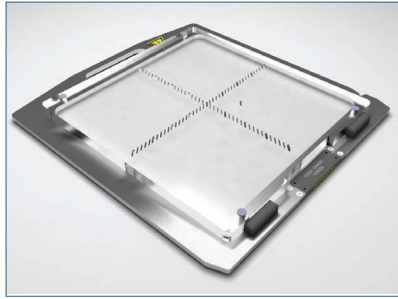

GRADIC

REF: 54-045

The GRADIC is similar to the Standard Siemens Graticule except that it is intended to be used with the Siemens Artiste LINAC. It interfaces into slot 3 of the Siemens 160 MLC LINACs.

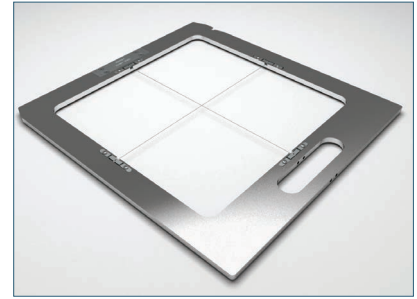

XRETIC

REF: 54-225

The XRETIC is intended to be used for external beam radiation therapy to project central axis cross-hairs within the radiation beam. It is compatible with Siemens LINAC from Siemens software release 2.0 and forward. It is intended to be used with Photons only. The Reticule is intended to be attached to Siemens Digital Linear Accelerators in slot 3. It is useful for performing panel alignment QA, setting image quality phantom alignment, and for performing flat panel alignment calibration.

	Standard Graticule	GRADIC	XRETIC
Compatibility	Siemens Pimus and Oncor LINACs	Siemens Artiste	Siemens Artiste
Construction	Markers within an acrylic block, mounted on metal frame	Markers within an acrylic block, mounted on metal frame	Aluminum frame with open center and tungsten wires
Adjustment	0.25" in X and Y directions	0.25" in X and Y directions	$\pm (0.060") 1.5\text{mm}$
Re-calibration	Locking brakes help fix acrylic plate to reduce re-calibration	Locking brakes help fix acrylic plate to reduce re-calibration	Not applicable
Insert Location	Slot 2	Slot 3	Slot 3
Marker Material	Tungsten	Tungsten	Tungsten wire
Marker Size (actual)	0.04" radius \times $\frac{1}{2}$ " length	0.04" radius \times $\frac{1}{2}$ " length	0.019" diameter
Weight	2kg (0.9 lbs)	1.2kg (2.6 lbs)	0.55kg (1.2 lb)
Marker Span (@ iso)	40 \times 40cm	40 \times 40cm	40 \times 40cm at 100cm SSD
Marker Spacing (@ iso)	1cm (small) and 5cm (large)	1cm (small) and 5cm (large)	not applicable
Digital Code	S2N18	GRADIC	Siemens Digital Code XRETIC
Orientation Marker	One off-diagonal marker allows for easy film orientation	One off-diagonal marker allows for easy film orientation	None

Photon Lead Block System

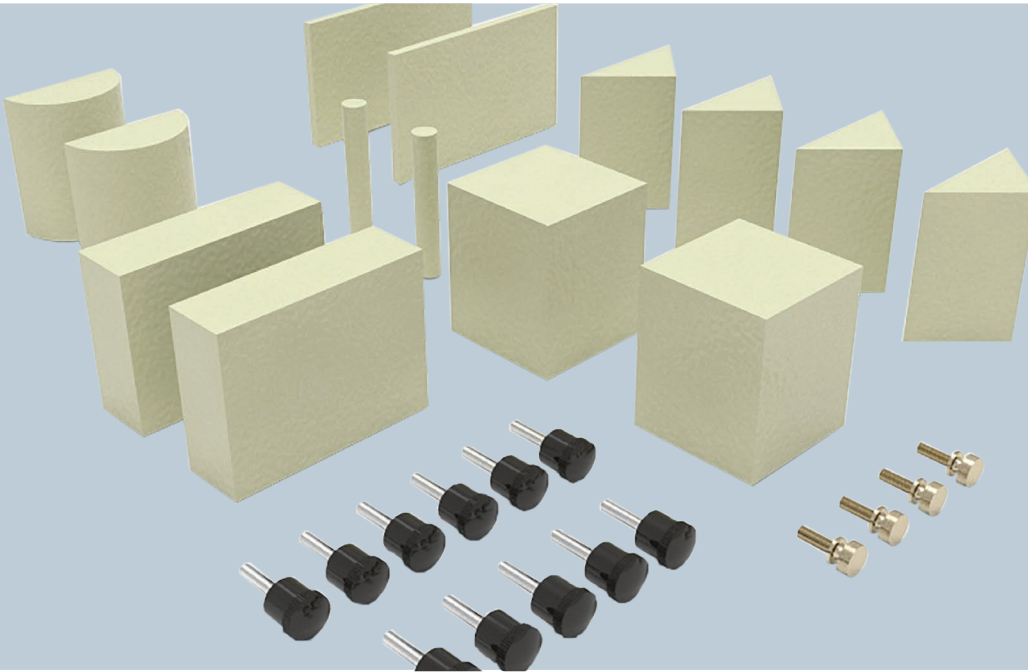

Lead Block Kit

The Lead Block Kit consists of 14 pre-shaped clinical lead blocks. They are configured into two systems: one to be used with photon energies 6MV or less, and other for photon energies greater than 6MV. All surfaces are covered with white powder-coat paint. The provided screws allow the blocks to be attached to standard 3/8" beam block trays. The eye blocks are attached to the beam block trays with a single screw. All other lead blocks are attached with two screws. The system weighs 30 lbs. The block thicknesses are chosen by NCRP Report No. 102: thickness of lead required to reduce beam to 5%.

Part Number (REF:)	Number Energy	Thickness
53-418	≤6MV	6cm
53-426	>6MV	8cm

Qty 2	Semicircular (kidney) - 50mm diameter
Qty 2	Square - 50mm x 50mm
Qty 2	Square (spinal cord) - 13mm x 100mm
Qty 4	Triangular - 40mm x 40mm
Qty 2	Circular (eye) - 10mm diameter
Qty 2	Rectangular - 25mm x 80mm
Qty 11	Standard Thumb Screws - 8/32 x 3/4"
Qty 4	Eye Block Thumb Screws - 8/32 x 1/2"

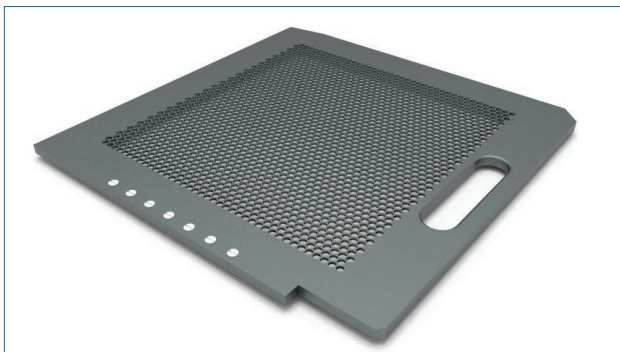

Mesh Trays

The mesh trays are made of aluminum and fit into the LINAC beam block tray slot. The high density hole pattern allows for flexible positioning of blocks within the field. The thickness of the aluminum within the mesh area is 2.0mm.

Part Number (REF:)	Compatibility
11-300	Elekta
53-168	Siemens
53-169	Varian



PRIMALERT 10 Teletherapy Radiation Monitor

REF: 998USARD007

The PRIMALERT® 10 Teletherapy Radiation Monitor is compact and responds to scatter radiation.

A pair of bright red lamps on the instrument face flash a warning when the source is exposed and continues until safe conditions are re-established. The flashing green operation indicator light denotes continuous monitoring of background radiation and provides visible indication that the instrument is functioning. The monitor comes with a self-stick wall-mounting bracket and an AC adaptor/power converter.

Key Features

- Easy setup and installation
- Flashing lights indicate source is exposed
- Line-operated

PRIMALERT is a Registered Trademark of Fluke Biomedical

Technical Specifications

Detector	Energy-compensated GM tube
Accuracy	+/- 20% from 60 keV to 2 MeV
Alarm trip level	Switch-selectable at 2.5 or 20 mR/hr
Alarm	Two flashing red lamps with a 180° field of view. Alarm ceases when radiation falls below trip level
Power Requirements	Line-operated with UL-listed converter (105 to 125 V ac, 60 Hz to 12 V dc)
Dimensions (WxDxH)	15.24 cm x 8.89 cm x 3.81 (6 in x 3.5 in x 1.5 in)
Weight	0.91 kg (2 lb)

Rigid Water

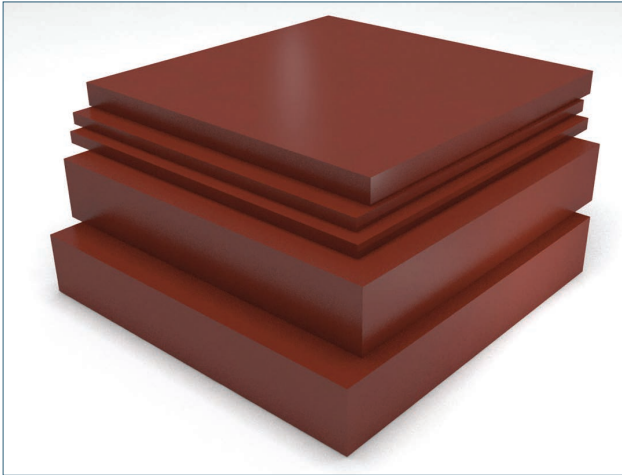

Rigid Water

Rigid Water simulates the absorption characteristics of water over a wider range of energies from 6MV to 21MV photons and from 6MeV to 18MeV electrons. Measurements will be identical to water within 1% over a broad range of the depth dose curve. Rigid Water plates can be machined by Aktina to accept your ion-chamber.

Rigid water plates are available in 30x30cm sizes over a range of thicknesses from 0.2cm to 5.0cm. Ion-chamber cavities can be machined in plates 2cm or greater.

Part Number (REF:)	Description
1201-30	Rigid Water Phantom. Varying Thickness. 30cm x 30cm x 30cm
1201-30-02	Rigid Water Plate. 30 x 30 x 0.2cm
1201-30-05	Rigid Water Plate. 30 x 30 x 0.5cm
1201-30-10	Rigid Water Plate. 30 x 30 x 1.0cm
1201-30-20	Rigid Water Plate. 30 x 30 x 2.0cm
1201-30-50	Rigid Water Plate. 30 x 30 x 5.0cm

Photon Comparison

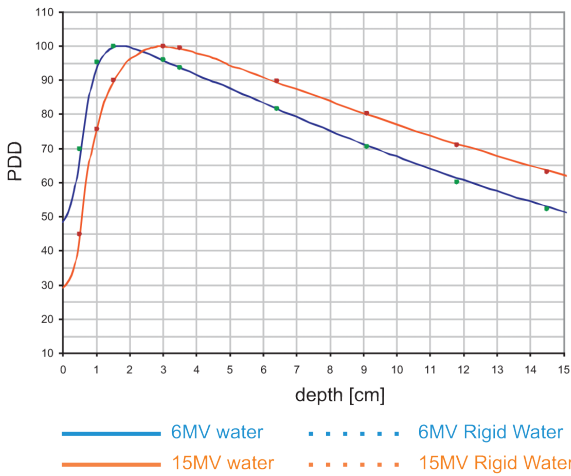

Electron Comparison

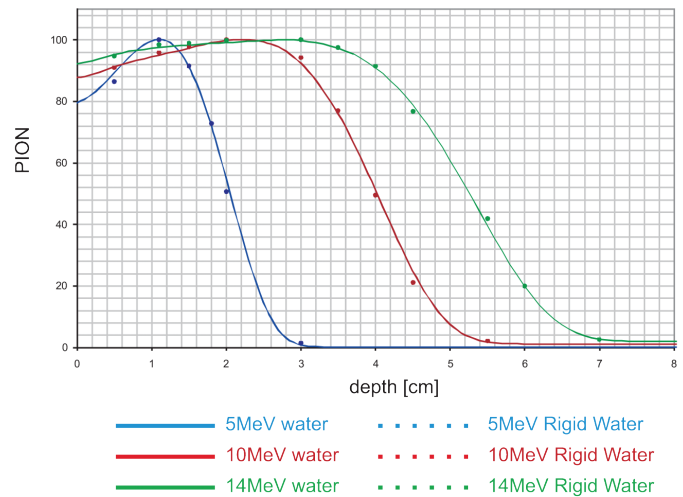

Rigid Water Physics Phantom

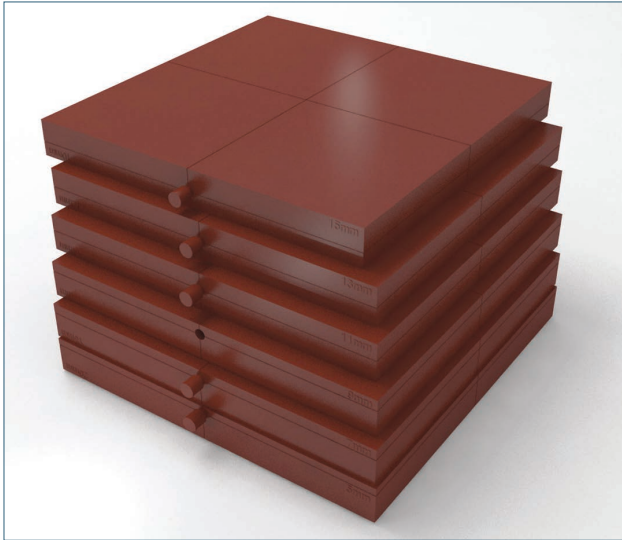

Rigid Water Physics Phantom

The Aktina Rigid Water Physics Phantom is designed to allow for rapid dose measurements without the need for water phantoms. The water equivalent material, combined with a wide array of ion-chamber positions, allows the physicist to position the chamber in increments of 2mm over a large depth dose range, which is necessary for routine electron output QA. The Phantom consists of 6 slabs, each with cross-hairs and clear labels indicating depth of ion-chamber from both the top and bottom surface. 5 filler rods are provided to fill the ion-chamber holes that are not being used.

By manipulating the stacking of the phantom plates, it is possible to obtain the following combination of ion-chamber depths:

Possible Ion-chamber Depths in mm:					
5	30	55	80	105	130
7	32	57	82	107	132
9	34	59	84	109	134
10	35	60	85	110	135
11	36	61	86	111	136
12	37	62	87	112	137
13	38	63	88	113	138
14	39	64	89	114	139
15	40	65	90	115	140
16	41	66	91	116	141
17	42	67	92	117	142
18	43	68	93	118	143
19	44	69	94	119	144
20	45	70	95	120	145
21	46	71	96	121	146
22	47	72	97	122	147
23	48	73	98	123	148
24	49	74	99	124	149
25	50	75	100	125	150
26	51	76	101	126	151
28	53	78	103	128	153
30	55	80	105	130	155

Ion-Chamber Cavities

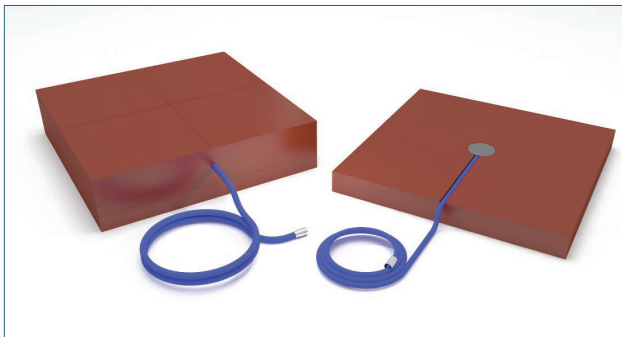

Part Number (REF:)	Description
1201-C01	Chamber Well for PTW Semiflex 31002 / 31010
1201-C02	Chamber Well for PTW PinPoint 31014
1201-C03	Chamber Well for Capintec Farmer, 0.6 cc PR-06C
1201-C04	Chamber Well for PTW Farmer Type, 0.6 cc, 30006 / 30013
1201-C05	Chamber Well for Wellhofer Farmer Type, 0.65 cc FC65-G
1201-C06	Chamber Well for PTW Advanced Markus, 0.02 cc, 34045
1201-C07	Chamber Well for PTW ROOS, 0.035 cc, 34001

Ion-chamber cavities can be machined in plates 2cm.

Please contact Aktina for additional ion-chamber options.

Protos Phantom



The Protos Phantom is a simple and elegant solution for 3D dose verification where high-accuracy spatial resolution of penumbras is critical. The phantom has an easy to use modular slab design with precision manufactured film pockets at each level. The phantom can be oriented with the film in either the coronal or axial orientation.

A 3-point leveling base with spirit level ensures proper setup. The slabs are light-tight so they can be used within a dark room environment, or with Gafchromic type film. The phantom can be customized based on user's request to be compatible with full range of ion-chambers, MOSFET, or TLDs.

Technical Specifications

Material	Aktina Rigid Water
Overall Size	24cm cube
Slab Thickness	2.5cm and 1.5cm
Number of Slabs	9 slabs of 2.5cm 1 slab of 1.5cm
Film Type	Precision cut Kodak EDR2 or Gafchromic
Film Size	18.8cm x 18.8cm
Film Orientation	Coronal (standard) Axial (requires REF: 11-850-P03)
Dosimetry Options	Customizable to users request
Base Thickness	2.5cm
Leveling	3-point leveling system with spirit level on base
Weight	15kg

Ordering Information

Part Number (REF:)	Description
11-850	Protos Phantom, Standard Configuration Includes: 10 interchangeable slabs and leveling base
11-850-P03	Axial Chamber Slab
11-855	Protos EDR2 Film Pack. Pack of 45 precision cut films
11-856	Protos Gafchromic Film Pack. Pack of 25 precision cut films

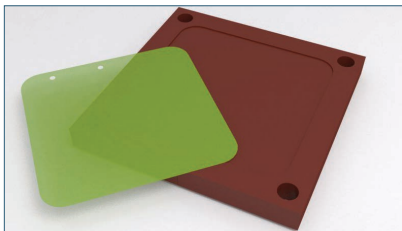

Precision cut film stacks fit within each slab of the phantom and provide a flexible and accurate means for positioning film.



The phantom slabs assemble on 4 Rigid Water posts, which makes phantom setup extremely simple.

Configure the Protos Phantom Easily to Meet a Wide Variety of Clinical Needs

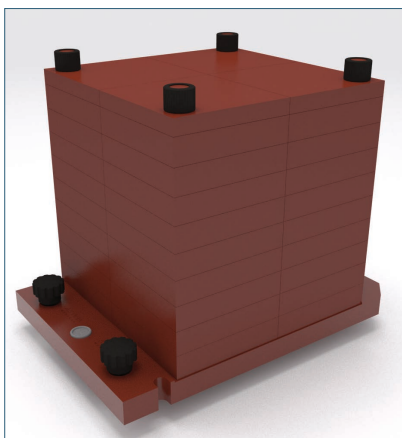

Axial Setup Fully Assembled

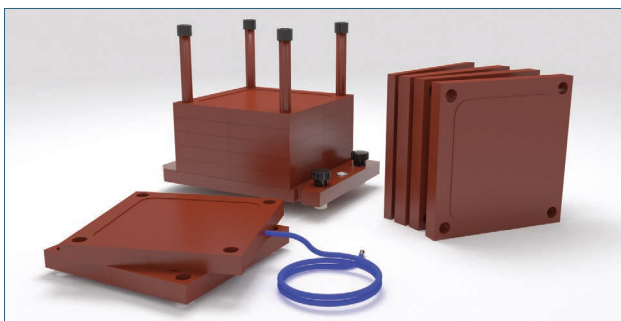

Axial Setup Fully Disassembled

The standard configuration of the phantom allows for both simultaneous ion-chamber and film measurements. Since the phantom is a 24cm x 24cm x 24cm cube, it can be positioned in multiple orientations within the same phantom base. In the standard configuration, the cube is oriented so that the slabs position the film in the coronal plane, with the ion-chamber positioned parallel to the film just slightly above or below the film.

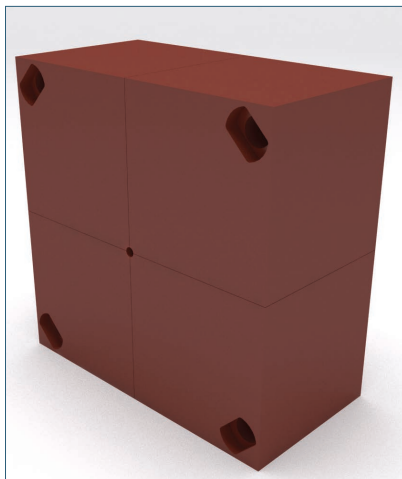

Protos Phantom Axial Chamber Slab

REF: 11-850-P03

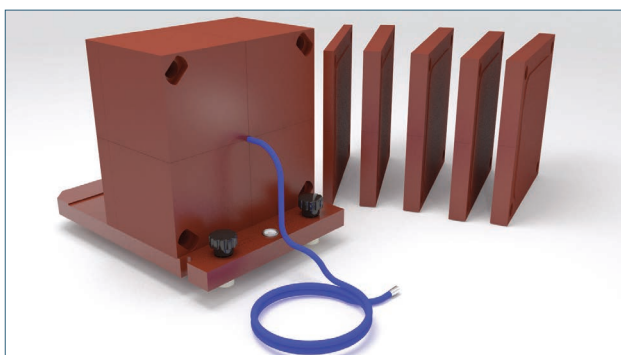

Coronal Setup Disassembled

To position the ion-chamber perpendicular to the film, with the film in the axial plane, an additional component is required. The Axial Chamber Module (REF: 11-850-P03, shown to the left) allows for the phantom cube to be rotated so that the film is in the axial orientation, while the direction of the ion-chamber is maintained along the patient's superior-inferior axis.

Film Cassette Holders

Mobile Cassette Holder

REF: 11-335

The Aktina Universal Cassette Holder is the only model on the market with bearing systems to allow for easy cassette positioning. Movable parts glide smoothly and effortlessly. It can be used with all radiation units, mobile and fixed diagnostic x-ray units for cross table views, brachytherapy localizing operating rooms and many other applications. The most versatile mobile cassette holder, it provides a simple, quick and efficient means to position any size x-ray film cassette. Precision angle indicators, quick locking mechanisms, and long horizontal and vertical travel adjustments permit accurate positioning of the cassette at all angles. Mechanical scales ensure accurate, reproducible alignment of the distance and angle of the film with respect to the direction of the beam. Movements are counterbalanced to ensure easy adjustment for the user.

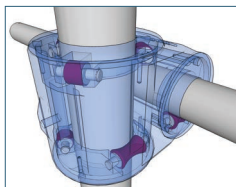

8 rotation bearings create smooth frictionless travel of all components



Indexed Cassette Positioning	Fully Indexed
Weight	145 lbs (67kg)
Overall Height	76" (193cm)
Maximum Cassette Height	70" (178cm)
Minimum Cassette Height	14" (36cm)
Base Dimensions	19" x 24" (48cm x 61cm)
Arm Range	36" (91cm)
Cassette Tilt Range	180°
Cassette Rotation Range	360°
Cassette Dimensions	Universal - accepts all film cassette sizes
Assembly	Some assembly required

Indexed Cassette Positioning	No indexing
Weight	3.6 lbs (1.6kg)
Overall Height	13" (33cm)
Maximum Cassette Height	2.6" (6.6cm) above top of rail
Minimum Cassette Height	0.6" (1.5cm) below top of rail
Arm Range	2.5" to 10" from rail (6.4cm to 25.4cm)
Cassette Tilt Range	Does not tilt
Cassette Rotation Range	360°
Cassette Dimensions	8" x 10" and 14" x 7"
Assembly	Non required



Lateral Cassette Holder

REF: 11-235

This versatile cassette holder mounts and locks onto the accessory railing of the treatment couch top. The specially designed, dual-sided locking mechanism ensures a simple, quick and efficient means of positioning a film cassette. It is easily maneuverable along the accessory rails within the midsection of the cassette arm and the cassette holder portion, to allow a variety of treatment positions.

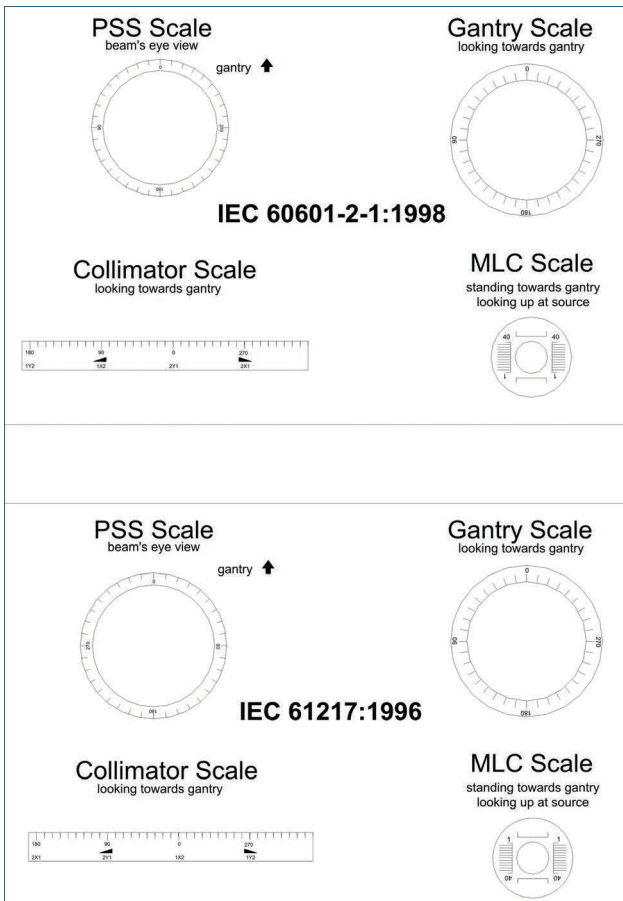
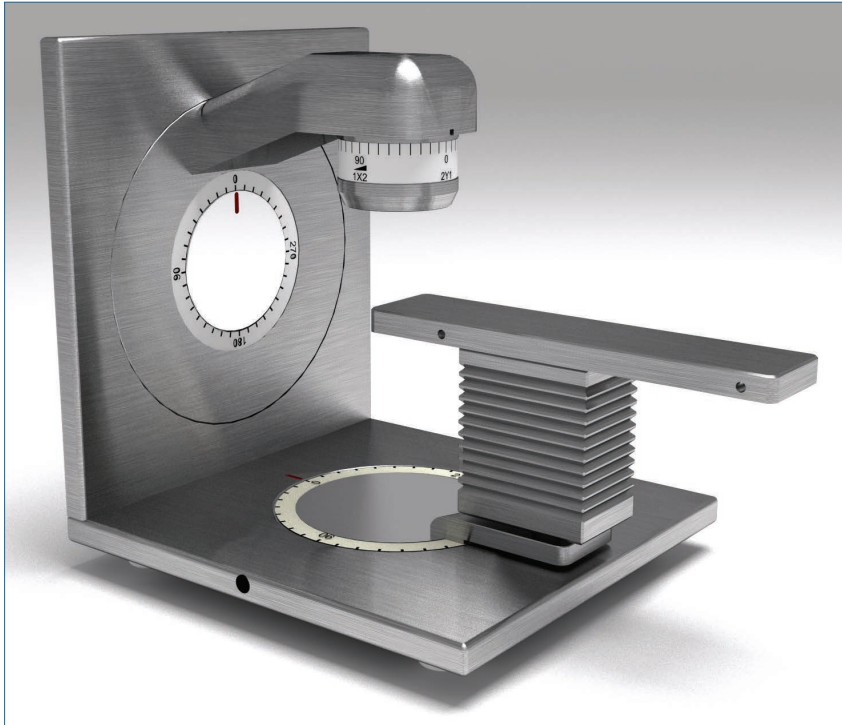

Model Linac IEC 60601 Scale. The Aktina Model LINAC simulates 5 of the real movements of an MLC equipped LINAC. It is intended to be used as a Treatment Planning and teaching aid. The design uses solid aluminum construction with precision movements.

Part Number (REF:)	IEC Standard
11-900-601	IEC 60601-2-1:1998
11-900-1217	IEC 61217:1996

Material	60601 Aluminum
Finish	Hard Anodized
Scaling Convention	IEC 60601-2-1:1998 or IEC 61217:1996
Gantry Rotation	270°
Collimator Rotation	270°
Couch Rotation	210° (about beam axis) 270° (about couch support structure)
Table Movement	8.2cm (approx 1.6m in real scale)

Wedge Filter Kits



Elekta External Wedge Set

REF: 11-495

The Elekta External Wedges come in a set of 4 wedges: 15°, 30°, 45°, and 60°. All the wedges are direct-mount so they connect directly to the collimator head of the Elekta LINAC. The wedges are coded with beam-block tray coding values: 122 through 125.

Angles	Set of 4: 15°, 30°, 45°, and 60°
Wedge Material	A36 steel
Wedge Plate Material	0.25" aluminum
Source to Wedge Distance	55.2cm
Wedge Angle Accuracy	±5°
15° Wedge Weight	5.3kg (11.6 lbs)
30° Wedge Weight	6.5kg (14.4 lbs)
45° Wedge Weight	9.1kg (20.0 lbs)
60° Wedge Weight	8.6kg (19.0 lbs)
Maximum Field Size	25cm × 30cm 15 through 45° wedges
Maximum Field Size	20cm × 30cm 15 through 45° wedges
Coding	Beam block tray codes 122 through 125



Siemens In-Plane Wedges for Oncor or Primus

REF: 56-300-MI

Siemens Oncor and Primus Wedge Sets

The Siemens Full Wedge Set has four wedge filters that are intended to be used in slot 2 of the Siemens Oncor and Primus LINACs. Each wedge can be inserted in 2 coded directions. The In-Plane wedge has the wedge direction along the direction of the treatment table, while the Cross-Plane wedge has the wedge perpendicular to the direction of the treatment table.

Wedge Material	Cold Rolled Steel
Wedge Material Density	7.81g/cm ³
Coding	1RW15M through 4RW60M
15° Wedge Max Field Size	25cm × 30cm
30° Wedge Max Field Size	25cm × 30cm
45° Wedge Max Field Size	25cm × 30cm
60° Wedge Max Field Size	20cm × 30cm
15° Wedge Central Axis Thickness	0.89cm
30° Wedge Central Axis Thickness	1.74cm
45° Wedge Central Axis Thickness	3.38cm
60° Wedge Central Axis Thickness	3.03cm



Siemens Cross-Plane Wedges for Oncor or Primus

REF: 56-300-MX

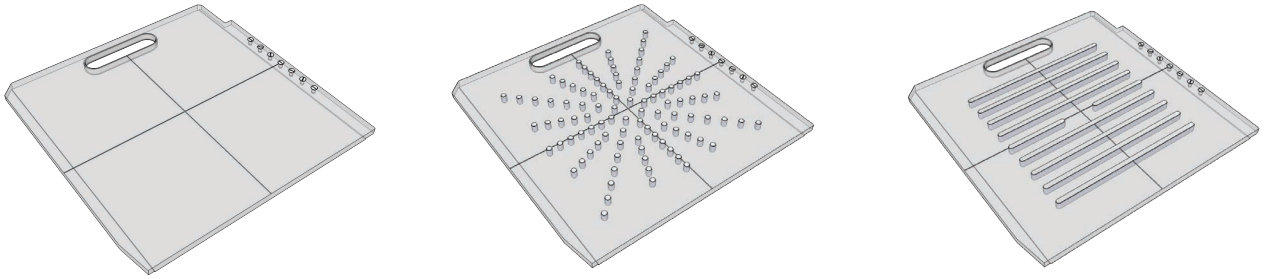

A variety of beam block trays are available with difference hole patterns, coding options, and LINAC compatibility.

Part Number (REF:)	LINAC Hole	Pattern	Material	Coding
11-570	Elekta	Solid	3/8" polycarbonate	Customer defined
11-571	Elekta	Star	3/8" polycarbonate	Customer defined
11-572	Elekta	Slotted	3/8" polycarbonate	Customer defined
52-600-HL	Siemens	Star	3/8" polycarbonate	Conventional non-MLC 600
52-600-SL	Siemens	Solid	3/8" polycarbonate	Conventional non-MLC 600
54-000-HL	Siemens	Star	3/8" polycarbonate	MLC (no coding supplied)
54-000-SL	Siemens	Solid	3/8" polycarbonate	MLC (no coding supplied)
55-000-HL	Siemens	Star	3/8" polycarbonate	Digital, non-MLC LINAC (1-200)
55-000-SL	Siemens	Solid	3/8" polycarbonate	Digital, non-MLC LINAC (1-200)
56-000-HL	Siemens	Star	3/8" polycarbonate	Digital, MLC LINAC (1-200)
56-000-SL	Siemens	None	3/8" polycarbonate	Digital, MLC LINAC (1-200)
57-901	Siemens	Solid	3/8" polycarbonate	both MLC and non-MLC
57-905	Siemens	Star	3/8" polycarbonate	both MLC and non-MLC
AKT-CL-1	Varian	Star	3/8" polycarbonate	none
AKT-CL-2	Varian	Solid	3/8" polycarbonate	none
AKT-CL-3	Varian	Slotted	3/8" polycarbonate	none



Siemens Coding plugs can be ordered separately. The coding plugs are provided in values of 1 through 220. Please request specific desired coding plug values at the time of order.

Part Number (REF:)	Description
REF: 57-956	Digital nonMLC Coding Plug, Siemens
REF: 57-957	Digital MLC Coding Plug, Siemens

LAP Room Laser Systems

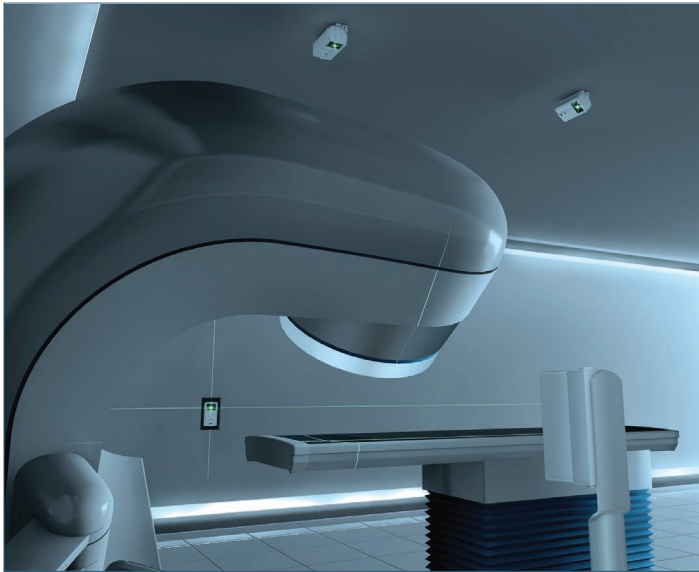

The APOLLO and ASTOR laser system provides state-of-the-art in-room patient alignment for Radiation Oncology. The high precision red and green DPSS lasers for the linear accelerator or simulator room have an integrated mounting bracket allowing for +/- 45 degree angulation of the laser. The system has a six micro-motor driven remote control adjustments mechanism.

The ASTOR system requires manual adjustments while the APOLLO has remote control capability for simple and easy adjustments of the lasers to the room isocenter.

Both systems have the following adjustment capability:

- Up/down horizontal line movement
- Crosshair rotation
- Up/down horizontal line tilt
- Right/left vertical line tilt
- Focus (line width)

Technical Specification

Product Name	ASTOR RED	ASTOR GREEN	APOLLO RED	APOLLO GREEN	APOLLO BLUE
Line Width (up to 4m distance)	< 1mm	< 1mm	< 1mm	< 1mm	< 0.5 mm
Line Length (at 3m distance)	5m	3m	4m	3m	3m
Laser Type	Diode	Diode Pumped Solid State	Diode	Diode Pumped Solid State	Diode
Wavelength	635 nm	532 nm	635 nm	532 nm	450 nm
Output Power	< 1 mW	< 1 mW	< 1 mW	< 1 mW	< 1 mW
Laser Class	2	2	2	2	2
Supply Voltage	110/230 VAC, 5 VDC	110/230 VAC, 5 VDC	110/230 VAC, 5 VDC	110/230 VAC, 5 VDC	100/240 VAC
Internal Voltage	5 VDC	5 VDC	5 VDC	5 VDC	24 VDC
Power Consumption	1W	10W	1W	10W	1 W
Operating Temperature	0 – 40°C	15 – 30°C	0 – 40°C	15 – 30°C	15 – 30°C
Dimensions (H × W × D)	188 × 86 × 93mm	221 × 110 × 101mm	221 × 110 × 100mm	221 × 110 × 100mm	221 × 110 × 100mm
Weight	1.5kg	2.4kg	2.6kg	2.6kg	2.6 kg
Adjustment Accuracy at Isocenter	± 0.5mm	± 0.5mm	± 0.5mm	± 0.5mm	± 0.5mm

Ordering Information

Part Number (REF:)	Description
11-394	LAP Green Crosshair Laser, individual
11-394-R	LAP Remote Green Crosshair Laser, individual
11-395	LAP Green Line Sagittal Laser, single
11-395-R	LAP Remote Green Line Sagittal Laser, single
11-397	LAP Laser Room System. Green Diode.
11-397-R	LAP Laser Room System. Remote Green Diode.
11-405	LAP Red Crosshair Diode Laser, single
11-405-R	LAP Remote Red Crosshair Laser, single
11-410	LAP Red Line Sagittal Diode Laser, single
11-410-R	LAP Remote Red Line Sagittal Laser, single
11-412	LAP Laser Room System. Red Diode.
11-412-R	LAP Laser Room System. Remote Control Red Diode.
11-420	LAP Red Backpointer Laser
11-420-G	LAP Green Backpointer Laser
11-433	LAP APOLLO Blue Treatment Room Set
11-433-01	Blue APOLLO Crosshair Laser
11-433-02	Blue APOLLO Sagittal Line Laser

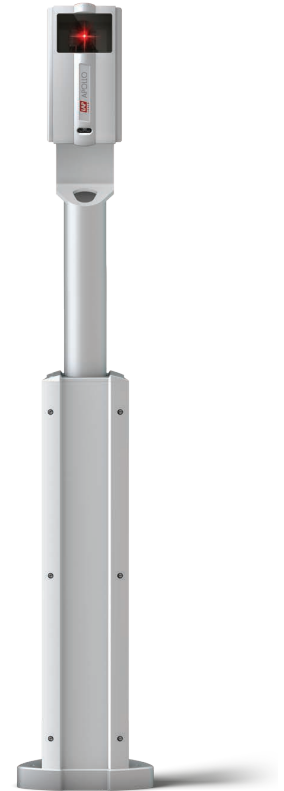

Optional Floor Mount

Contact Us



360 North Route 9W
Congers, NY 10920

Hours of Operation:
8:00am - 5:30pm EST

Toll-Free Phone: 888.433.3380
Phone: 845.268.0101
Fax: 845.268.1700

Email: info@aktina.com

Visit aktina.com for the latest product information.

March 2021

© 2021 Aktina Medical. All rights reserved. Specifications are subject to change without notice. Trademarks are the property of their respective copyright holders.

8254 NB 00

Index

Part Number (REF:)	Page(s)	Part Number (REF:)	Page(s)	Part Number (REF:)	Page(s)
11-200-05.....	29	1201-C02.....	57	50-820.....	7
11-200-08-01.....	27, 29	1201-C03.....	57	50-832.....	7
11-200-08-02.....	29	1201-C04.....	57	50-840.....	6
11-200-08-03.....	29	1201-C05.....	57	50-855.....	7
11-200-08-04.....	29	1201-C06.....	57	51-200.....	41
11-200-08-05.....	29	1201-C07.....	57	51-205.....	41
11-200-08-06S.....	29	35-960.....	48, 49	51-211.....	41
11-200-08-07.....	29	35-965.....	48, 49	51-215.....	41
11-216.....	41, 43	35-969.....	48, 49	51-216.....	41
11-216-S.....	43	40-003.....	35	51-220.....	41, 42
11-218-L.....	41, 43	40-013.....	35	51-230.....	41, 43
11-220-05.....	16, 23	40-023.....	35	51-231.....	45
11-229.....	16, 22, 23	40-033.....	37	51-235.....	43
11-229-09.....	16, 23	40-043.....	37	51-237.....	44
11-230.....	23	40-053.....	37	51-237-M.....	44
11-231-S.....	23	40-061.....	35	51-250.....	41, 42
11-235.....	60	40-062.....	35	52-600-HL.....	63
11-267.....	46	40-101.....	36	52-600-SL.....	63
11-268.....	46	40-102.....	36	52-626.....	48
11-269.....	46	40-121.....	36	52-914.....	48, 49
11-270.....	46	40-122.....	36	52-923.....	48, 49
11-272.....	47	40-201.....	36	53-046.....	46, 47, 48, 49
11-275.....	46, 47	40-202.....	36	53-050.....	48, 49
11-275-01.....	46, 47	40-221.....	36	53-104.....	51
11-300.....	54	40-222.....	36	53-168.....	54
11-305.....	47	40-271.....	37	53-169.....	54
11-306.....	47	40-275.....	37	53-418.....	54
11-335.....	60	40-278.....	37	53-426.....	54
11-344.....	52	40-281.....	37	53-459.....	48
11-345.....	52	40-511.....	38	53-460.....	48
11-346-M1.....	52	40-521.....	38	54-000-HL.....	63
11-360.....	51	40-541.....	38	54-000-SL.....	63
11-394.....	65	40-551.....	38	54-044.....	53
11-394-R.....	65	40-611.....	38	54-04.....	53
11-395.....	65	40-621.....	38	54-225.....	53
11-395-R.....	65	40-641.....	38	55-000-HL.....	63
11-397.....	65	40-651.....	38	55-000-SL.....	63
11-397-R.....	65	40-720.....	7	56-000-HL.....	63
11-405.....	65	40-721.....	7	56-000-SL.....	63
11-405-R.....	65	50-141.....	8	56-300-MI.....	62
11-410.....	65	50-144.....	9	56-300-MX.....	62
11-410-R.....	65	50-146.....	8	57-901.....	63
11-412.....	65	50-152.....	9	57-905.....	63
11-412-R.....	65	50-153.....	9	57-956.....	63
11-420.....	65	50-175.....	8	57-957.....	63
11-420G.....	65	50-215.....	9	60-100.....	14
11-433.....	65	50-220.....	8	60-310.....	19
11-433-01.....	65	50-222.....	9	60-311.....	19
11-433-02.....	65	50-225.....	9	60-312.....	19
11-495.....	62	50-227.....	9	60-320.....	18, 19
11-570.....	63	50-245.....	9	60-330.....	18, 19
11-571.....	63	50-251.....	11	60-505.....	15
11-572.....	63	50-251-01.....	11	60-522.....	15, 17, 18
11-850.....	58	50-250-02.....	11	60-525.....	15, 17
11-850-P03.....	58, 59	50-250-06.....	11	60-542.....	17
11-855.....	58	50-250-08.....	11	60-552.....	17
11-856.....	58	50-252.....	11	60-570.....	17
11-900-1217.....	61	50-265.....	8	60-812.....	16, 23
11-900-601.....	61	50-266.....	8	70-210.....	20, 21
12-200-03.....	27	50-302.....	13	998USARD007.....	55
12-200-04.....	27	50-305.....	13	ABC Transport.....	26
12-200-05.....	28	50-330.....	13	AK550.....	40-43
12-200-06.....	28	50-335.....	13	AKT-CL-1.....	63
12-200-07-10.....	28	50-370.....	12	AKT-CL-2.....	63
12-200-07-20.....	28	50-371.....	12	AKT-CL-3.....	63
12-200-07-30.....	28	50-455.....	9	Elekta ABC.....	24, 25
1201-30.....	56	50-460.....	9	PRIMALERT 10.....	55
1201-30-02.....	56	50-465.....	9	SP-1600A.....	39
1201-30-05.....	56	50-470.....	9	SP-1600D.....	39
1201-30-10.....	56	50-805.....	6	SpiroCheck Duo.....	30, 31
1201-30-20.....	56	50-806.....	6	Thermoplastics.....	32-39
1201-30-50.....	56	50-807.....	7		
1201-C01.....	57	50-810.....	7		